

Intelligent Imaging for an Improved Workflow

**NEW**

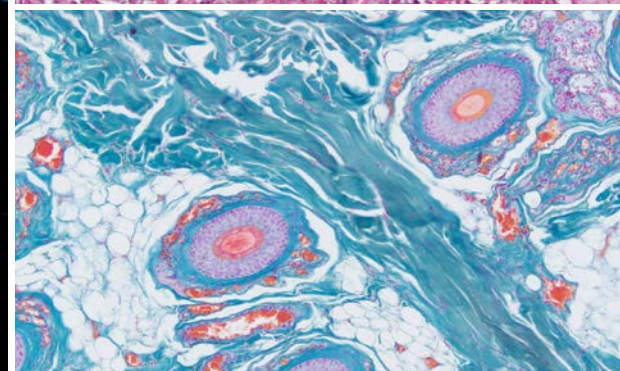
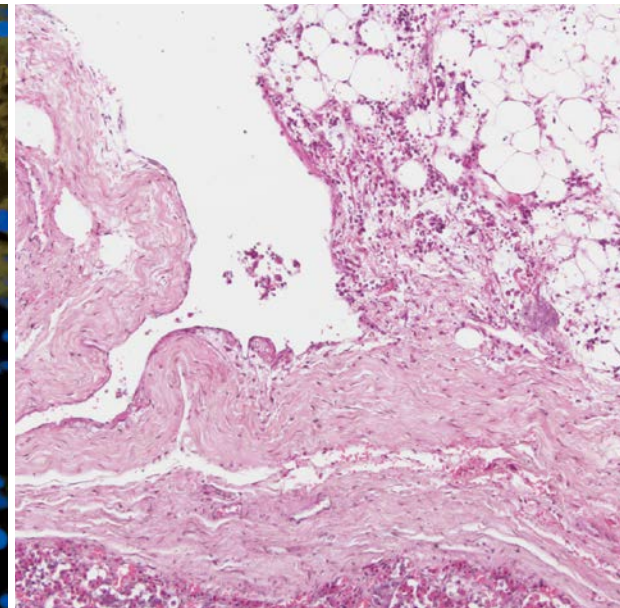
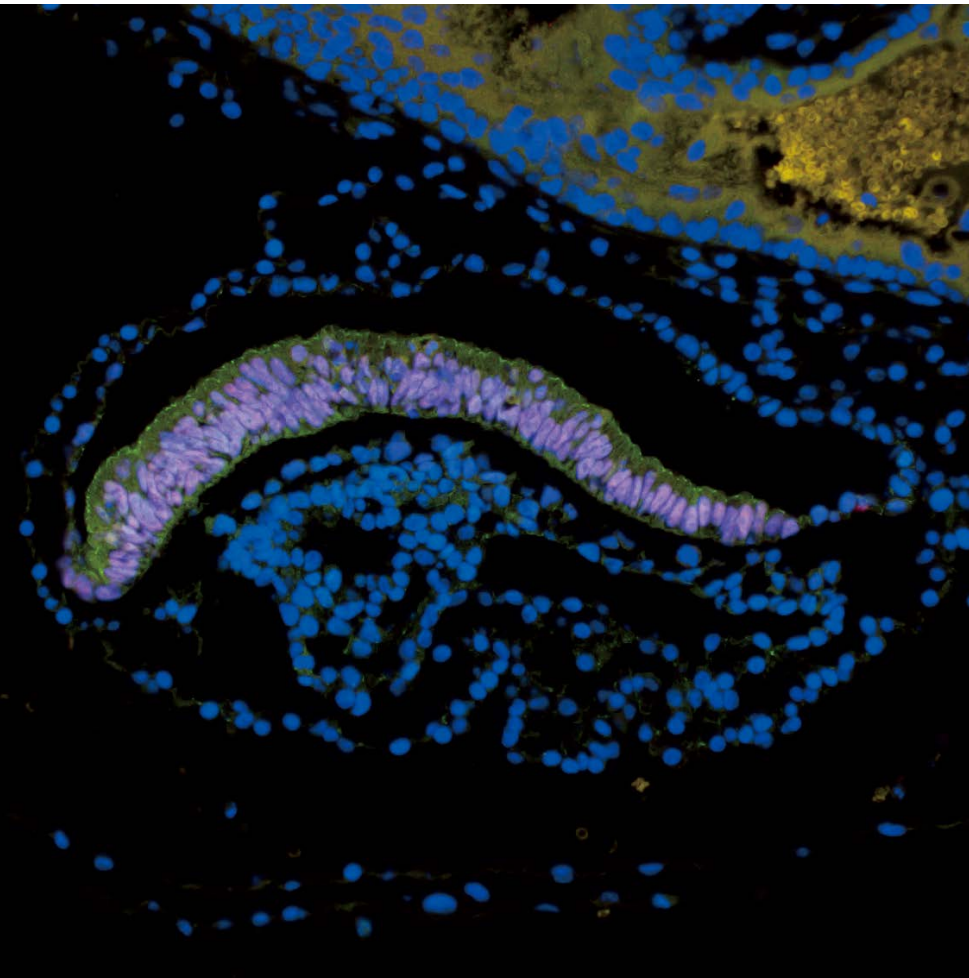

## Intuitive Workflow Enhancements for Easy Operation

The DP74 color fluorescence camera captures realistic, high-quality images and has features that enable users to make their observations easily. With a wide field of view, operators can capture images of more of their sample, quickly.

In applications like histology, the DP74 camera faithfully reproduces colors to render natural images of your specimen. The camera displays a realistic image, so what appears on the monitor looks the same as what users see looking through the microscope's eyepieces. Users can remain comfortable during their work since they can just watch the monitor rather than having to go back and forth between the monitor and eyepieces. The camera is easy to use, so it integrates into any workflow, making it simple to capture publication-quality images.

Enhanced features make the DP74 camera a powerful research tool. For applications like histology, where users need to regularly capture images for daily discussion, the position navigator keeps track of your location, so you will always know precisely where you are on your sample when making high-magnification observations. Optimized for fluorescence color imaging on live specimens, the live noise reduction feature seamlessly assists with focusing on dim fluorescent images.

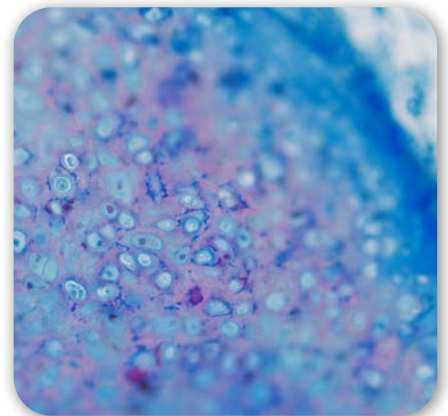
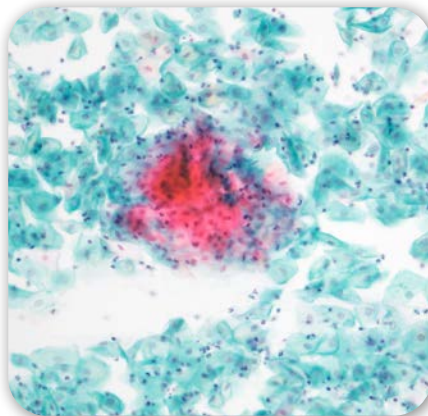
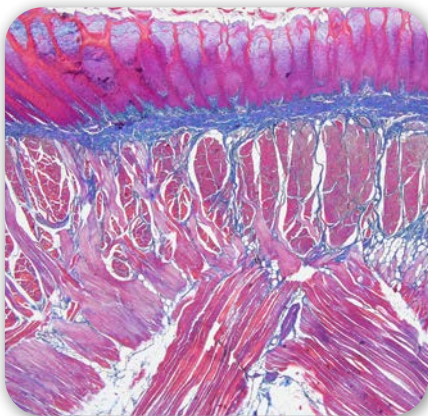
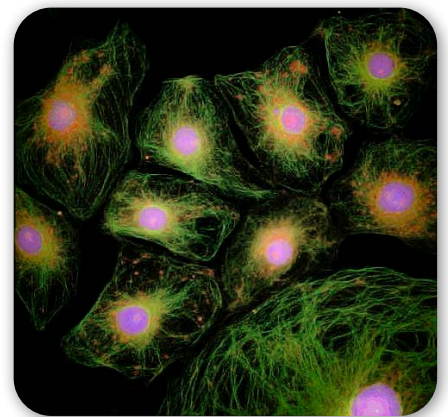
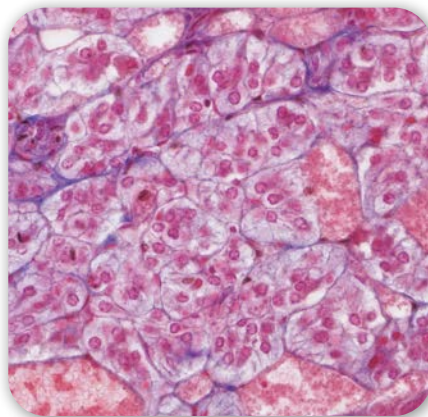
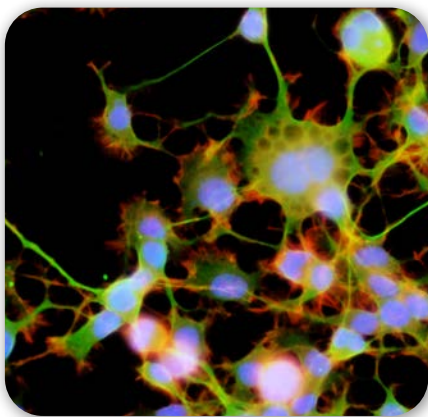

Fast, high sensitivity, and superior quality image with the latest CMOS technology.

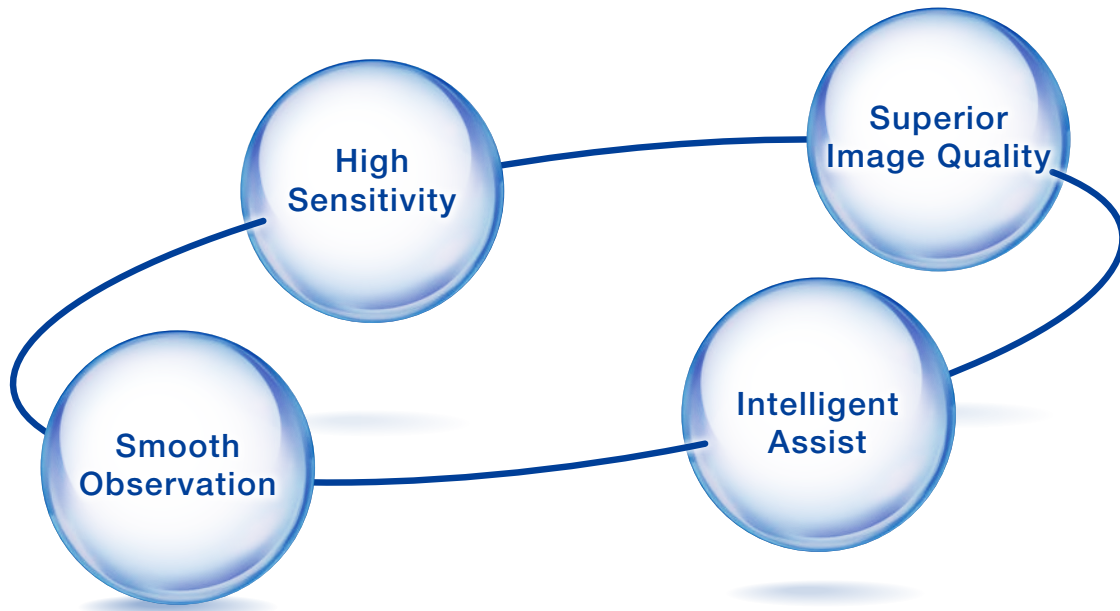

Smart camera navigation for comfortable observation.

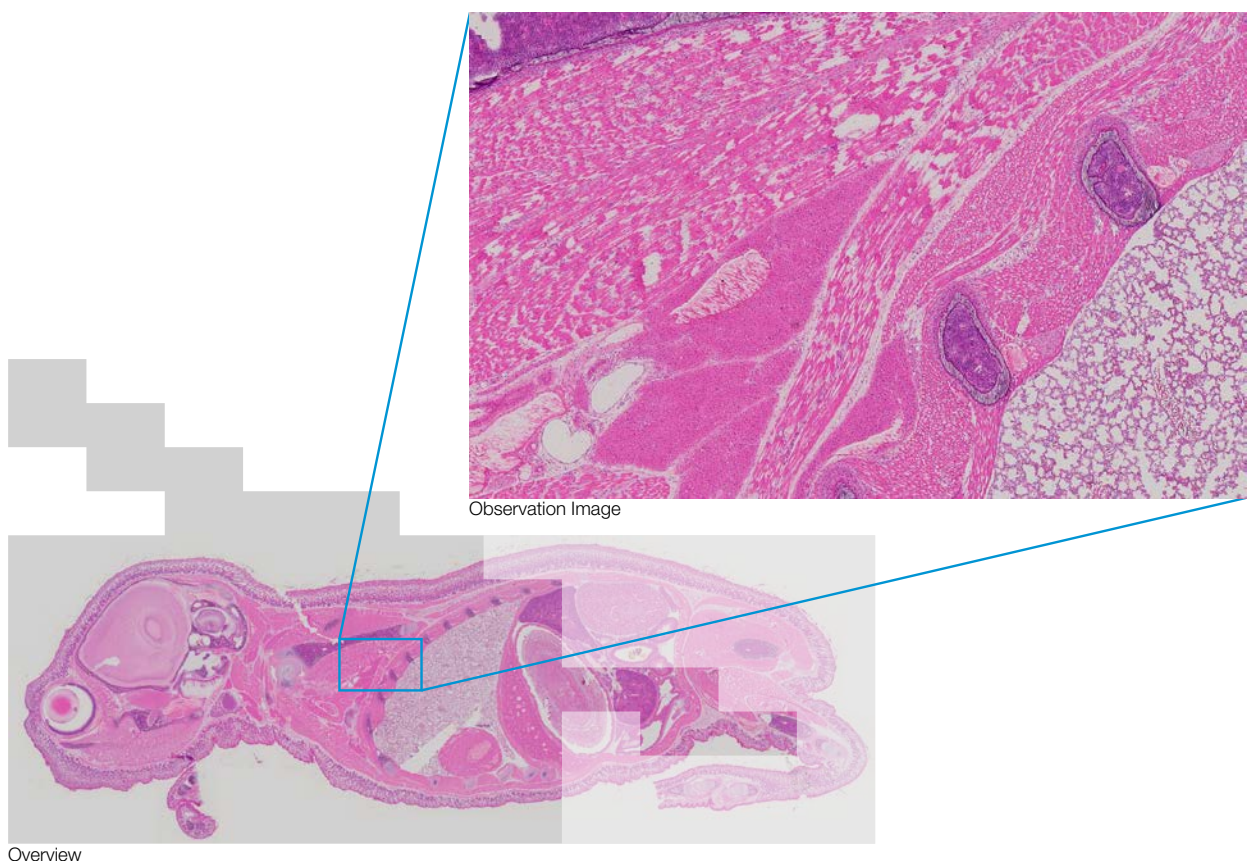

# Capture High-Quality Images Quickly and Easily

## Full HD Images of Live Specimens are Fast and Simple to Acquire

Obtain high-quality images of live specimens higher than FullHD resolution (2.3 million native pixels). The DP74 camera delivers images at a full 60 frames per second. The high frame rate enables users to make observations quickly and easily and capture fast movements in the specimen. The DP74's global shutter eliminates the live image distortion frequently caused by rolling shutter CMOSs.

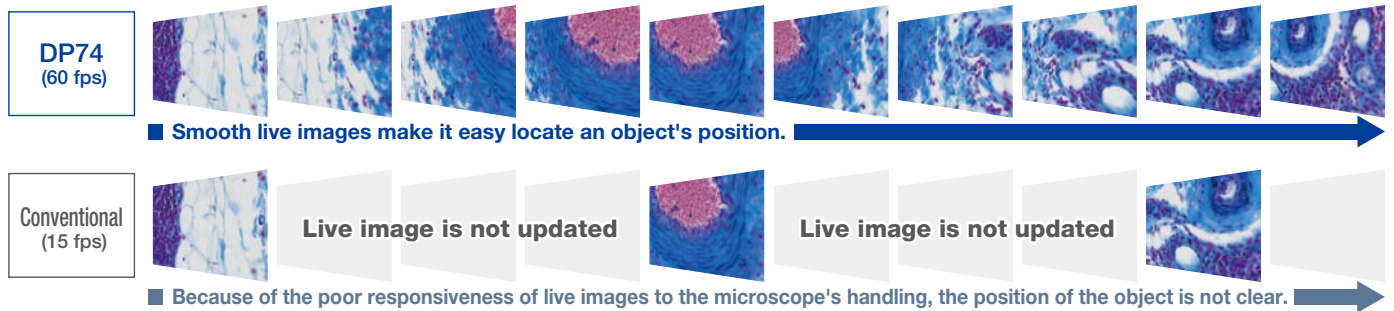

## One of the Widest Field of Views Available

The DP74 color fluorescence camera features a field of view that is 37% larger than conventional microscope cameras, which are typically the equivalent of FN 18 or less. The wide 16:10 aspect ratio field of view enables users to find areas of interest more quickly and recognize their position within a sample.

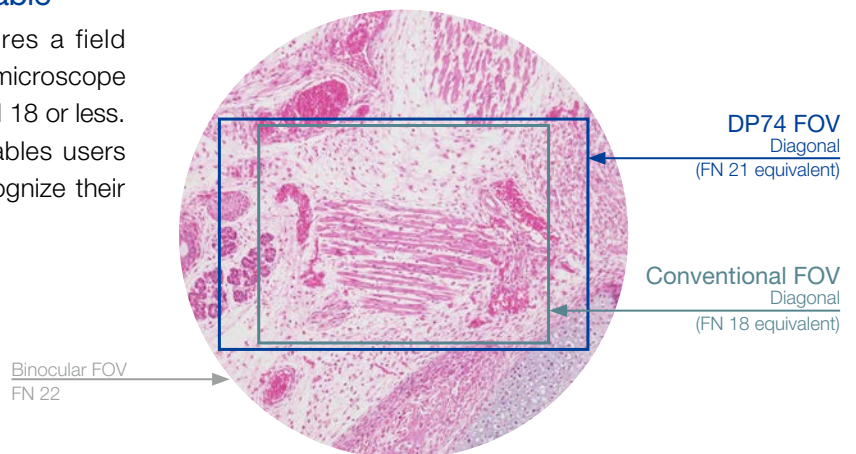

## High Color Fidelity for Most Stains Used in the Life Sciences

Olympus' proprietary image processing technology delivers excellent color reproducibility in a wide variety of stained samples. The color fidelity detects subtle shading, faithfully reproduces the tint from HE staining, light green from Papanicolaou staining, and brown from DAB staining.

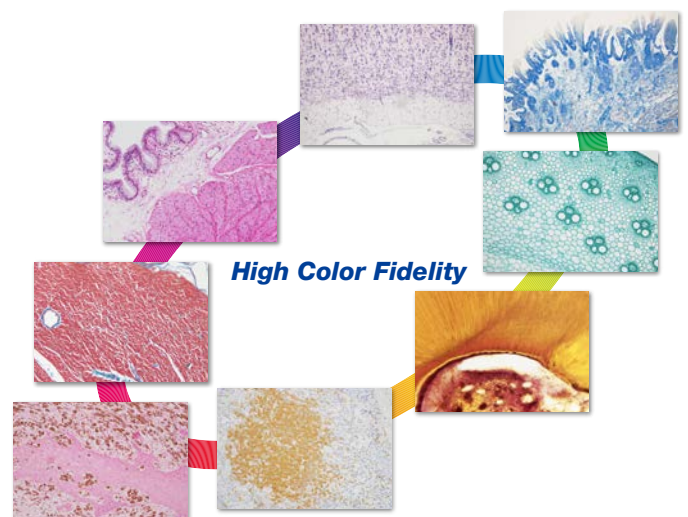

## Capture Fine Details at Low Magnifications

The DP74 camera provides high resolution at low magnification. The camera's pixel shifting technology provides sub-pixel information, delivering the equivalent of 20.7 million pixels in a high-resolution image. The 3-CMOS mode makes each pixel's information as accurate as three chip cameras. This provides more detail, creating high-definition images with fine color reproduction without increasing the file size.

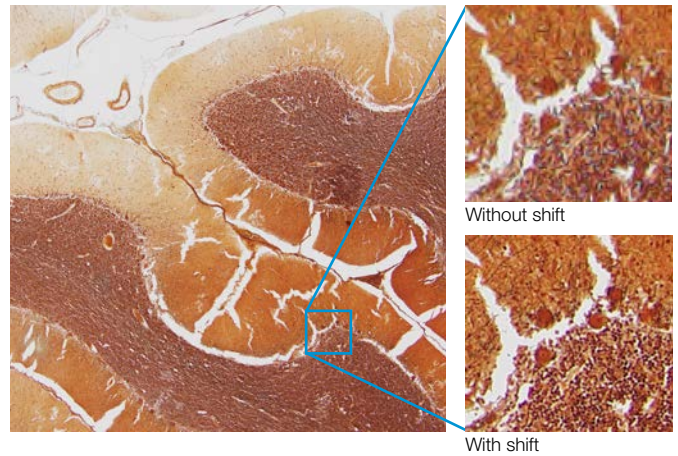

## Vivid Fluorescence Images with Reduced Noise

Because the CMOS sensor is cooled, it enables sharp fluorescence images with low noise and with sensitivity similar to or greater than a cooled CCD. The camera's 'Linear' mode provides accurate brightness data that is proportional to the number of sensed photons, so it is easier to analyze the brightness of fluorescence images.

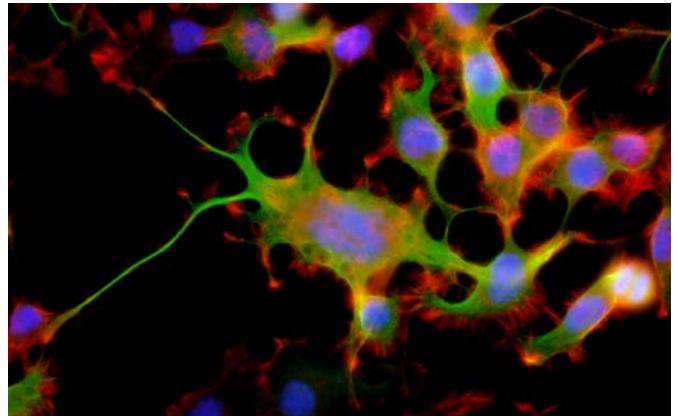

## Seamless Stitching with Even Illumination Across the Image

With the shading correction feature, it's possible to produce beautiful macro images with fewer seams. Tiling is faster thanks to the wider field of view and the fast frame rate, leading to beautiful macro images.

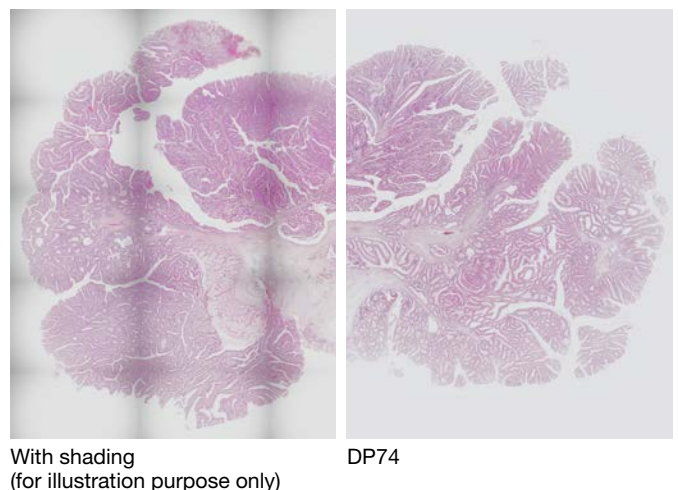

# Enhanced Efficiency and Comfort

## Easily know the location of interest with the Position Navigator

The position navigator adds convenience to the operator's workflow because it creates a map to help users keep track of their location within the specimen; this is especially useful when making observations at high magnification. This is achieved without the need for a motorized or encoded stage. The low-magnification map of the sample containing all of the pertinent location information can be stored along with the high-magnification observation image, making it convenient for record keeping or creating presentation materials.

\*The accuracy of the map creation and the position navigation depends on observed samples.

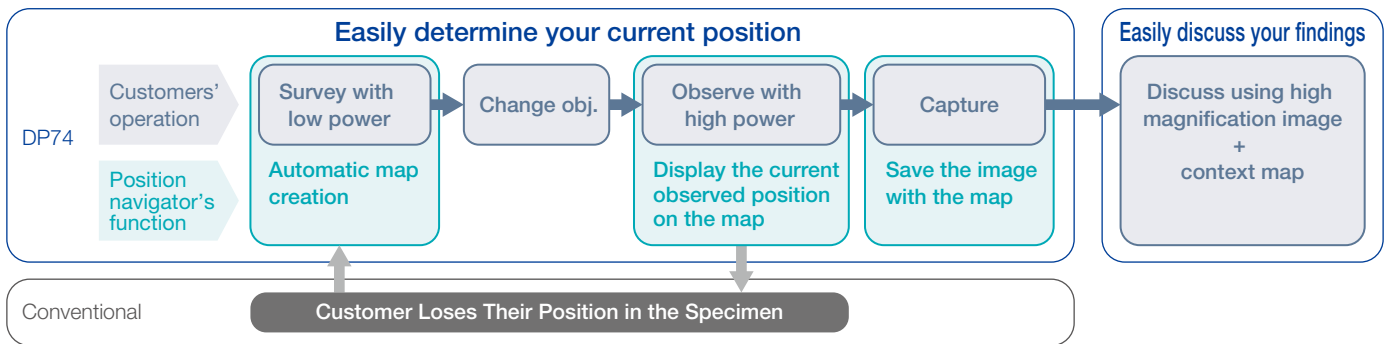
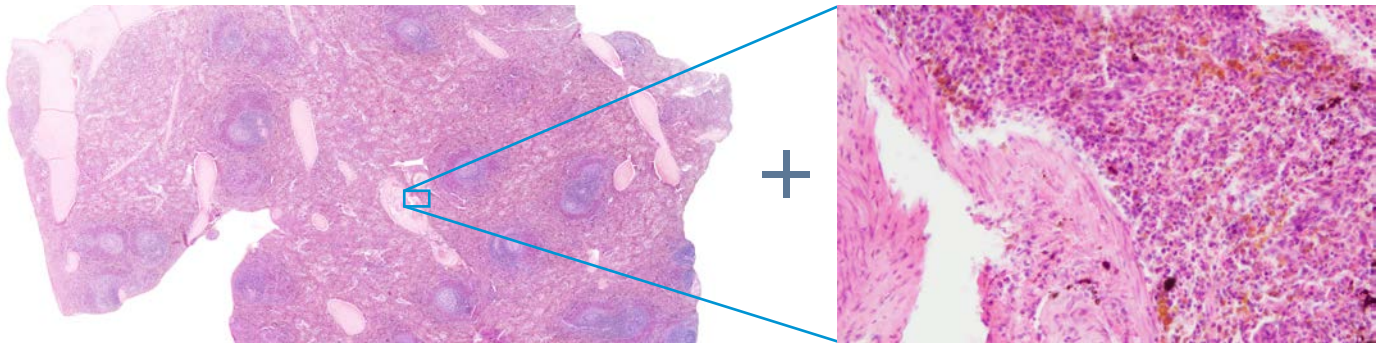

## Context Map And High-Magnification Images Stored in a Single File

The metadata images used in the camera's mapping feature can also be used as stand-alone images. In addition, the entire overview map and high-magnification image can be saved and exported in a common file format for enhanced flexibility. Users are able to place markers in real-time on the overview map to highlight potential areas of interest, making it easy to go back and re-image previously viewed areas.

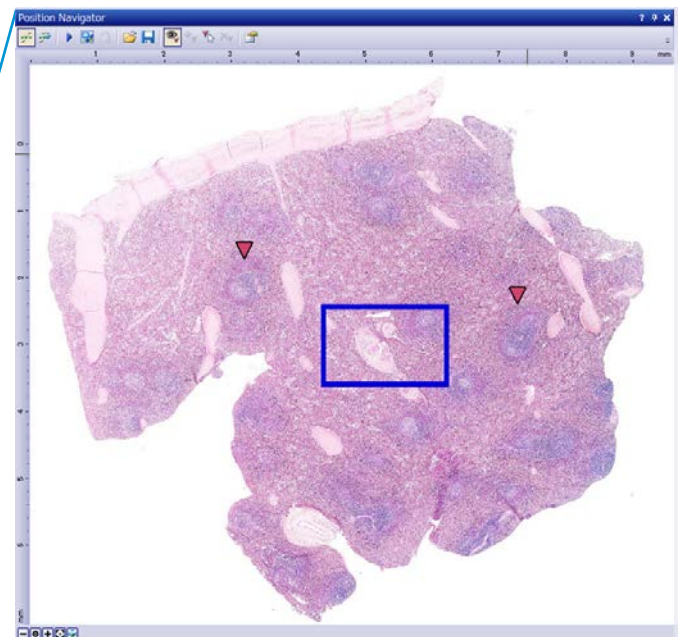
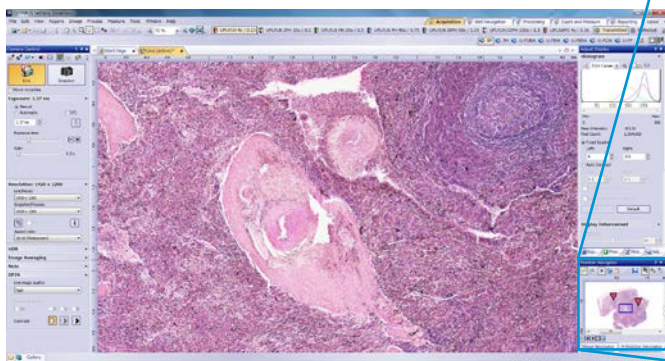

## Focus on Dim Fluorescent Signals with Intelligently Designed Noise Reduction

The multi-frame live noise reduction (FNR) feature makes it possible to capture low-noise, high-speed images of live specimens in real time. Olympus' noise reduction technology enables users to obtain sharp fluorescence images, even in weak fluorescence. The FNR feature takes multiple pictures of an image and then removes the random background noise. The camera is intelligent enough to be able to stop the FNR only when the stage is moving, making it easier to scan your specimen and focus during fluorescence imaging.

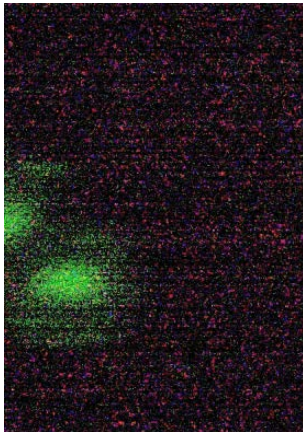

Maintain 15 fps using high gain

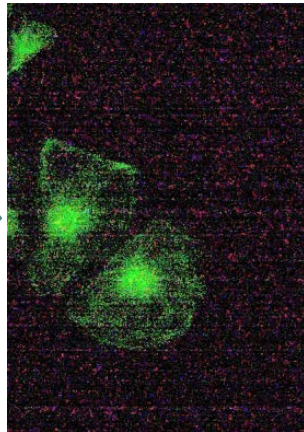

The FNR automatically starts after the stage stops

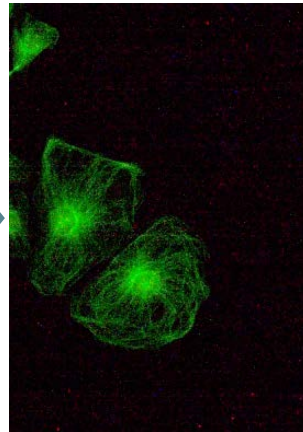

Customers can focus on live images with suppressed background noise

## Super Fluorescence (SFL) Mode Optimizes for Correct Exposure

The DP74 camera is equipped with SFL mode and is optimized for fluorescence observation. With SFL, the camera automatically sets the optimal exposure time to capture balanced fluorescence images, without losing details to overexposed areas.

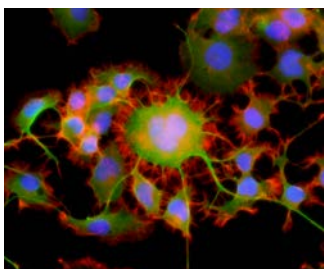

SFL

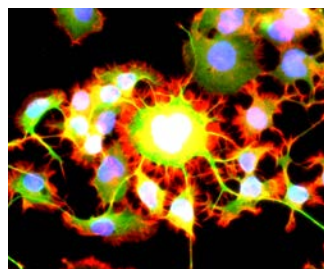

Without SFL



Cultured cell (MDA-MB-231) transduced with multiple fluorescent proteins. Image data courtesy of Dr.Yuji Mishima, The Cancer Chemotherapy Center, Japanese Foundation for Cancer Research

## The Auto Expose Feature Helps Prevent Overexposure When Changing Objectives

The DP74 fluorescence color camera automatically detects when a user changes objectives and waits until the image is uniformly illuminated before performing auto exposure. This helps prevent acquiring images that are overexposed and facilitates a smooth transition from one objective to the next.

## DP74 Specifications

Item	Specifications	
Camera type	Single chip color CMOS (pixel shifting) Cooling system: Peltier device	
Imaging Sensor Size	1/1.2 inch 2.35-megapixel color CMOS Global Shutter	
Camera mount	C-mount	
Effective image resolution*1	5760 × 3600 (pixel shifting, 3-CMOS mode) 2880 × 1800 (pixel shifting, 3-CMOS mode) 1920 × 1200 (1 × 1, 3-CMOS mode) 1920 × 1080 (1 × 1), 1600 × 1200 (1 × 1) 960 × 600 (1 × 1, 2 × 2) ROI	
Sensitivity	0.5X/1X/2X/4X/8X/16X (ISO 200 / 400 / 800 / 1600 / 3200 / 6400 equivalent)	
A/D	12 bit	
Metering modes	Mode	Auto, SFL-Auto, Manual
	Adjustment	±2.0 EV step: 1/3 EV
	Time	39 μs to 60 s
Metering modes	Full image, 30%, 1%, 0.1%	
Binning	2 × 2	
Live frame rate	1920 × 1200 (1 × 1): 60 fps*2, 1920 × 1080 (1 × 1): 60 fps*2	
Still image transfer time	5760 × 3600 (3 × 3): approx. 4 s 1920 × 1200 (1 × 1): approx. 0.3 s	
Color space	sRGB, AdobeRGB*3	
Image file format	File formats supported by cellSens software	
Position navigator*4	Available	
Dimensions	Camera interface cable	Approx. 2.5 m

## DP74 System Requirements

Item	PC/AT compatible
CPU	Intel Core i5, Intel Core i7, Intel Xeon, (or equivalent)
RAM*5	4 GB or more (dual-channel)
Extension slot*6	PCI Express X4 Rev.2.0 or later Half-size, low-profile PCIe board compatible (106.7 mm × 174.6 mm)
OS	Microsoft Windows 10 Pro (64 bit) Microsoft Windows 8.1 Pro (64 bit) Microsoft Windows 7 Ultimate / Professional SP1 (32 bit / 64 bit) Language: English / Japanese

\*1 Pixel shift and 3-CMOS mode images cannot be acquired in a 32-bit OS environment.

\*2 Frame rate may decrease depending on the condition of your PC and/or software.

\*3 Monitor designed to meet Adobe RGB is required.

\*4 Not available in the combination of cellSens Entry and DP2-TWAIN.

\*5 In order for the maximum full-size live frame rate to be achieved, both dual-channel and PC10600 or greater RAM is required.

\*6 Do not install large boards, like graphic boards, in the adjacent slot on the fan side of the DP74 camera's PCIe board. Please contact your nearest Olympus dealer for more information.

## DP74 System Diagram

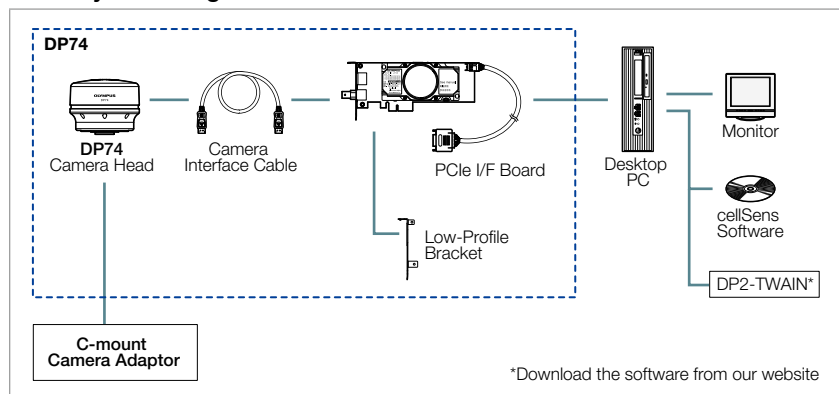

## DP74 Camera Head Dimensions

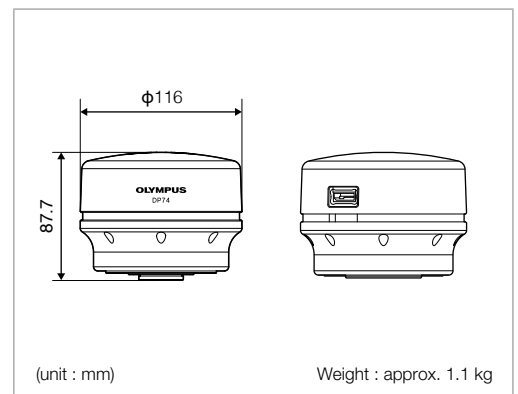

Immunofluorescence image of cynomolgus postimplantation embryo (16 days old), Red:OCT4, Green:SOX11

Image data courtesy of : Prof. Mitinori Saitou and Dr. Tomonori Nakamura, Anatomy and Cell Biology, Medicine and Medical Science, Graduate School of Medicine Kyoto university (Cover page, left)

- EVIDENT CORPORATION is ISO14001 certified.
- EVIDENT CORPORATION is ISO9001 certified.
- EVIDENT CORPORATION is ISO13485 certified.

- All company and product names are registered trademarks and/or trademarks of their respective owners.
- Images on the PC monitors are simulated.
- Specifications and appearances are subject to change without any notice or obligation on the part of the manufacturer.

EvidentScientific.com

**EVIDENT**

EVIDENT CORPORATION  
Shinjuku Monolith, 2-3-1 Nishi-Shinjuku, Shinjuku-ku, Tokyo 163-0910, Japan

**OLYMPUS**

N8600591-022023