

Life Science

# APEXVIEW APX100

## Benchtop Fluorescence Microscope

Exceptional Imaging Made Easy



**EVIDENT**

## Faster, Smarter Research Workflow

The APEXVIEW APX100 benchtop fluorescence microscope makes it fast and simple to acquire expert-quality microscope images to make your research more efficient. Built with renowned Olympus optics, an intuitive user interface, a powerful AI, and a suite of smart features, the APX100 system combines the ease of use of an all-in-one-microscope with high-quality image data to fit your research needs.

### Conventional



### APX100



- ▶ **Stay Focused** on Your Research
- ▶ **Publication-Quality Images** in a Few Clicks
- ▶ **Fast, Efficient** Data Management

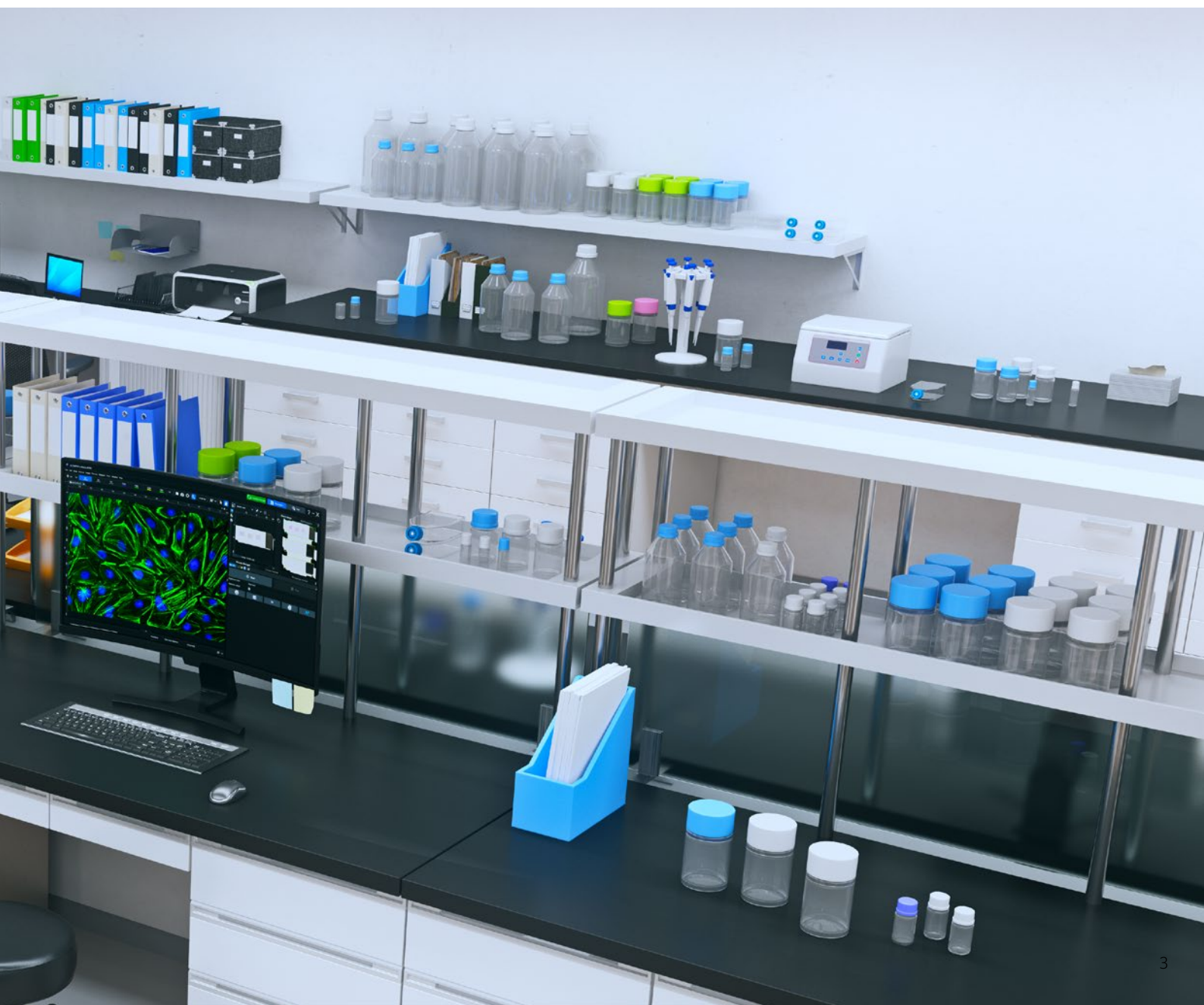





# Stay Focused on Your Research

## Spend More Time on Your Research with Automatic Sample Detection

When you place your sample in the sample holder, the APX100 system's **smart sample navigator** automatically acquires a macro image, and the built-in AI locates your sample on the slide. Once the system automatically centers your sample over the objective, it is displayed on the monitor so that you can choose the observation method and immediately begin capturing images.

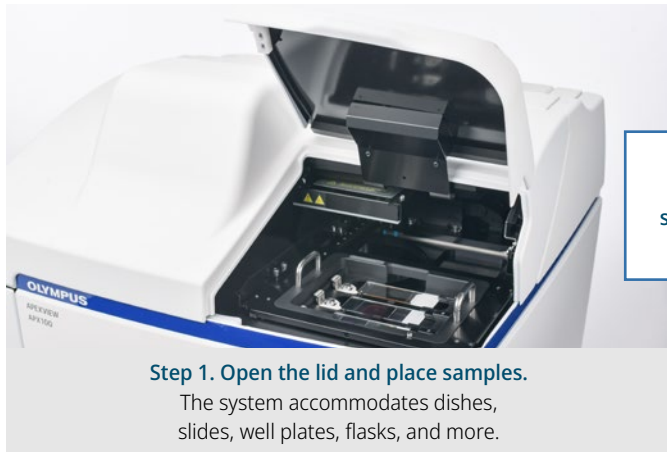

**Step 1. Open the lid and place samples.**  
The system accommodates dishes, slides, well plates, flasks, and more.

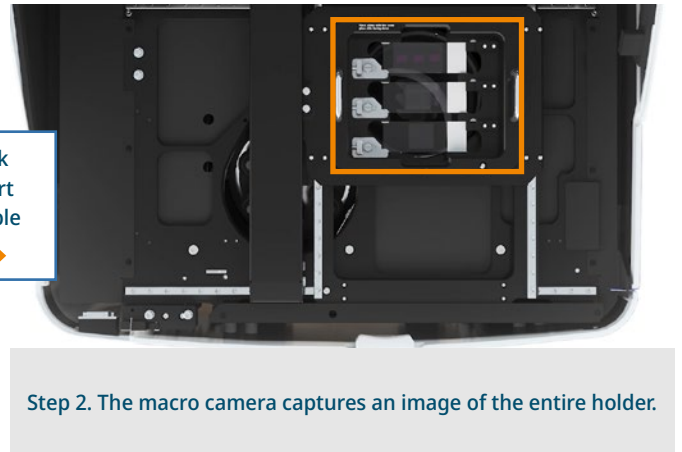

**Step 2. The macro camera captures an image of the entire holder.**

Image is processed by AI

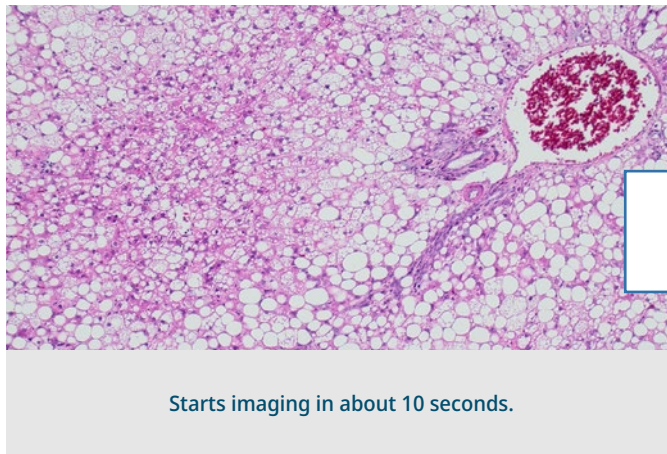

Starts imaging in about 10 seconds.

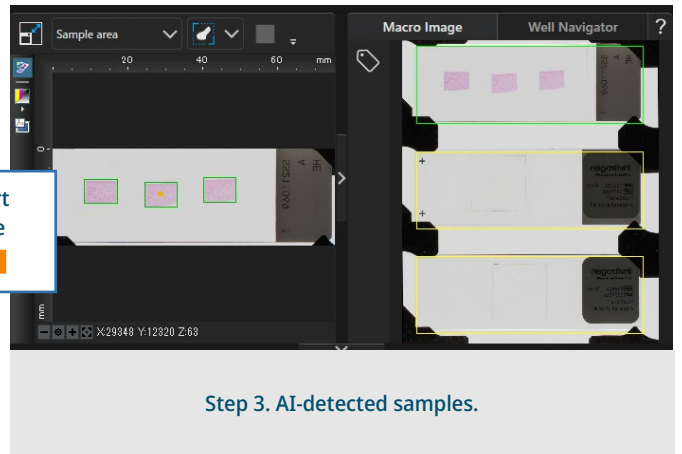

**Step 3. AI-detected samples.**

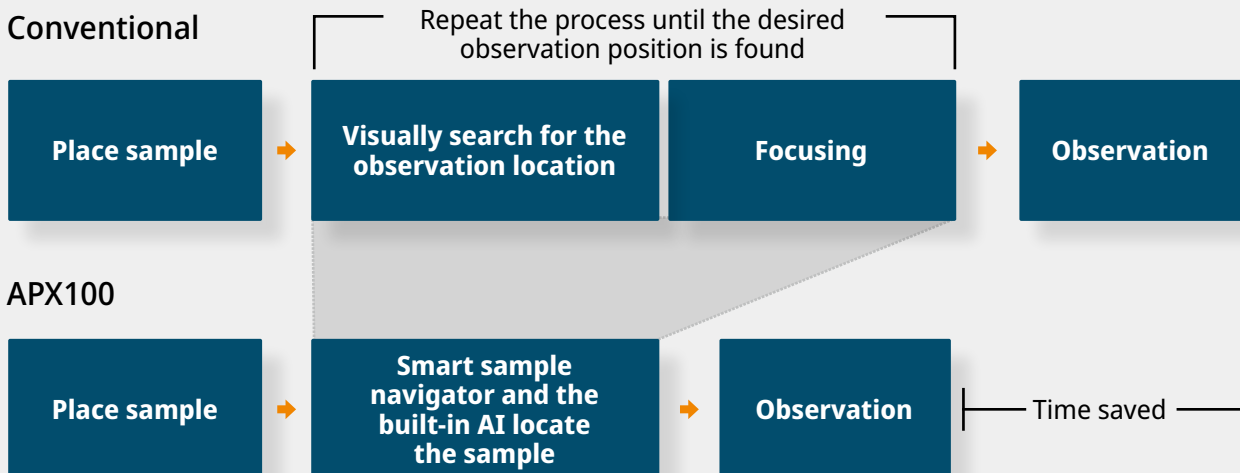

## Simple Layout and Workflow Maximize Efficiency

Using the APX100 system is simple—load the sample, close the lid, and click a button. The software’s clear layout and streamlined workflow help you start image acquisition with little training.

### Live View Window:

For basic operations such as switching objectives, observation methods, and live acquisition

### Stage Navigator:

Control XY movement and stitching settings

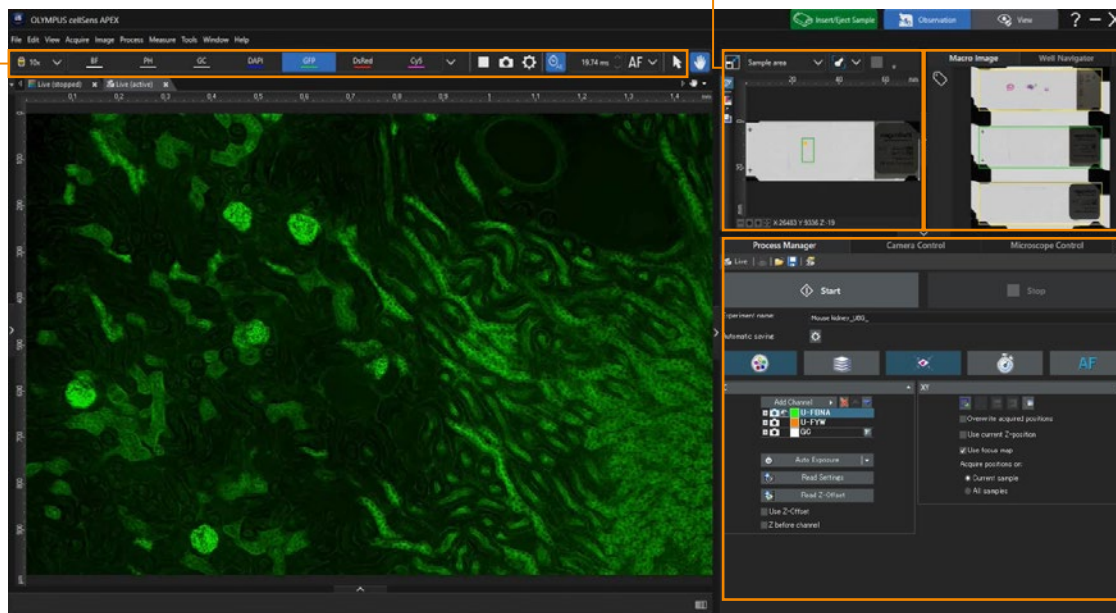

### Macro Image:

Display the entire holder

### Well Navigator:

Image acquisition settings with microplates

### Process Manager:

Multi-dimensional acquisition settings

### Camera Control:

Various camera settings such as exposure time

### Microscope Control:

Operation and settings for each microscope device

## High-Speed Autofocus

The system’s autofocus is up to twelve times faster than conventional autofocus algorithms, enabling you to quickly find the ideal imaging plane. With coordinated automation, you can spend less time searching for samples and more time collecting data.

See It in Action

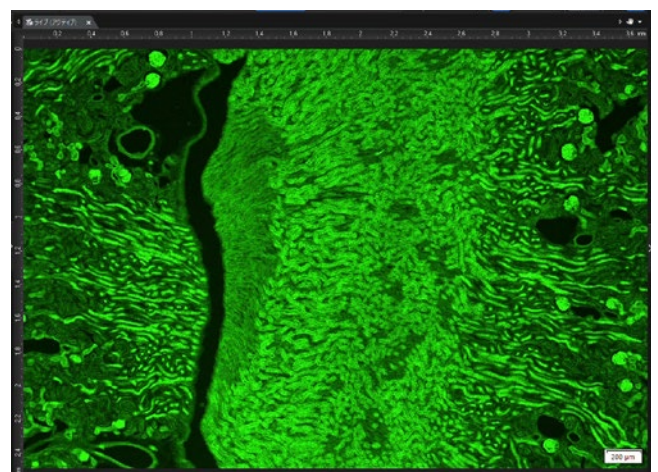
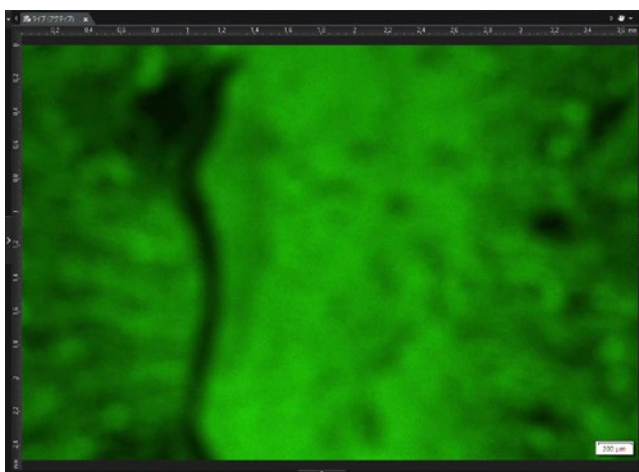

Up to twelve times faster than conventional autofocus algorithms



## Publication-Quality Images in a Few Clicks

With an optical system designed and built by Olympus, the APX100 system delivers the same quality optics and technology available in our high-end research microscopes. This means that you can easily acquire publication-quality images for a wide range of applications.

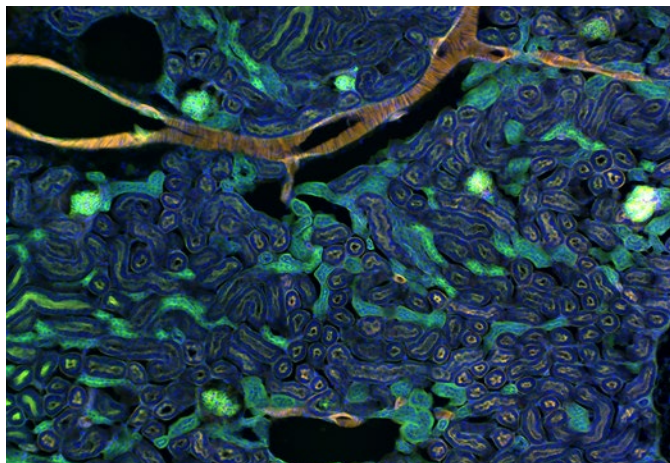

Mouse kidney. Alexa Fluor 488 WGA, Alexa Fluor 568 Phalloidin, DAPI.

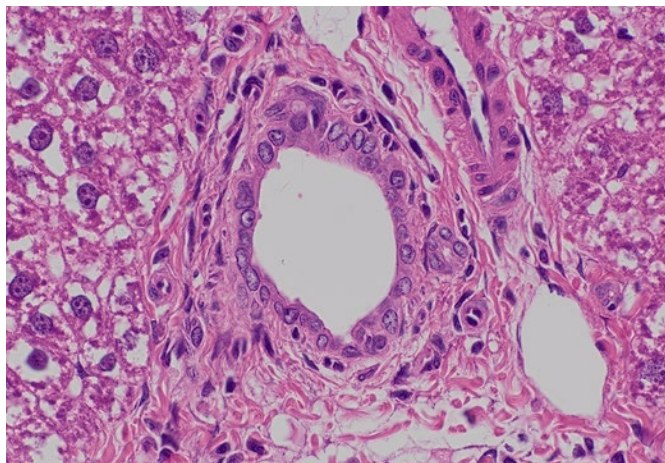

Rabbit liver. Stain: HE.

### Uncompromising Optical Technology

Many Olympus objectives—including our award-winning X Line and silicone oil immersion objectives—work with the APX100 system, providing the flexibility to get high-quality images for your research applications. The system's six-position revolving nosepiece makes it easy to observe samples at multiple magnifications, all with the simple click of a button.

The system also includes a high color rendering LED for outstanding transmitted light imaging and a broadband LED light source for fluorescence observation. Choosing a high-end camera configuration also allows you to check the details of your samples with accurate color reproduction, incorporating a high-quality monochrome camera.\*

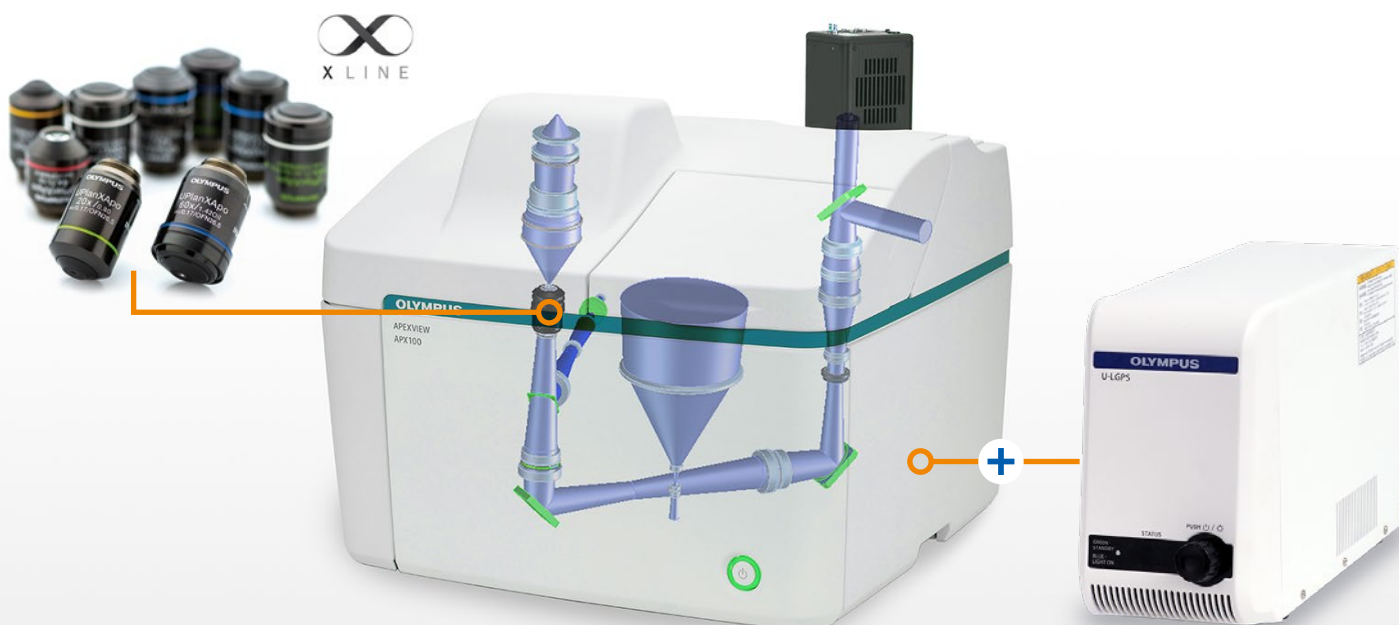

\*High-sensitivity cameras are only available in the high-end camera unit (HCU) configuration.



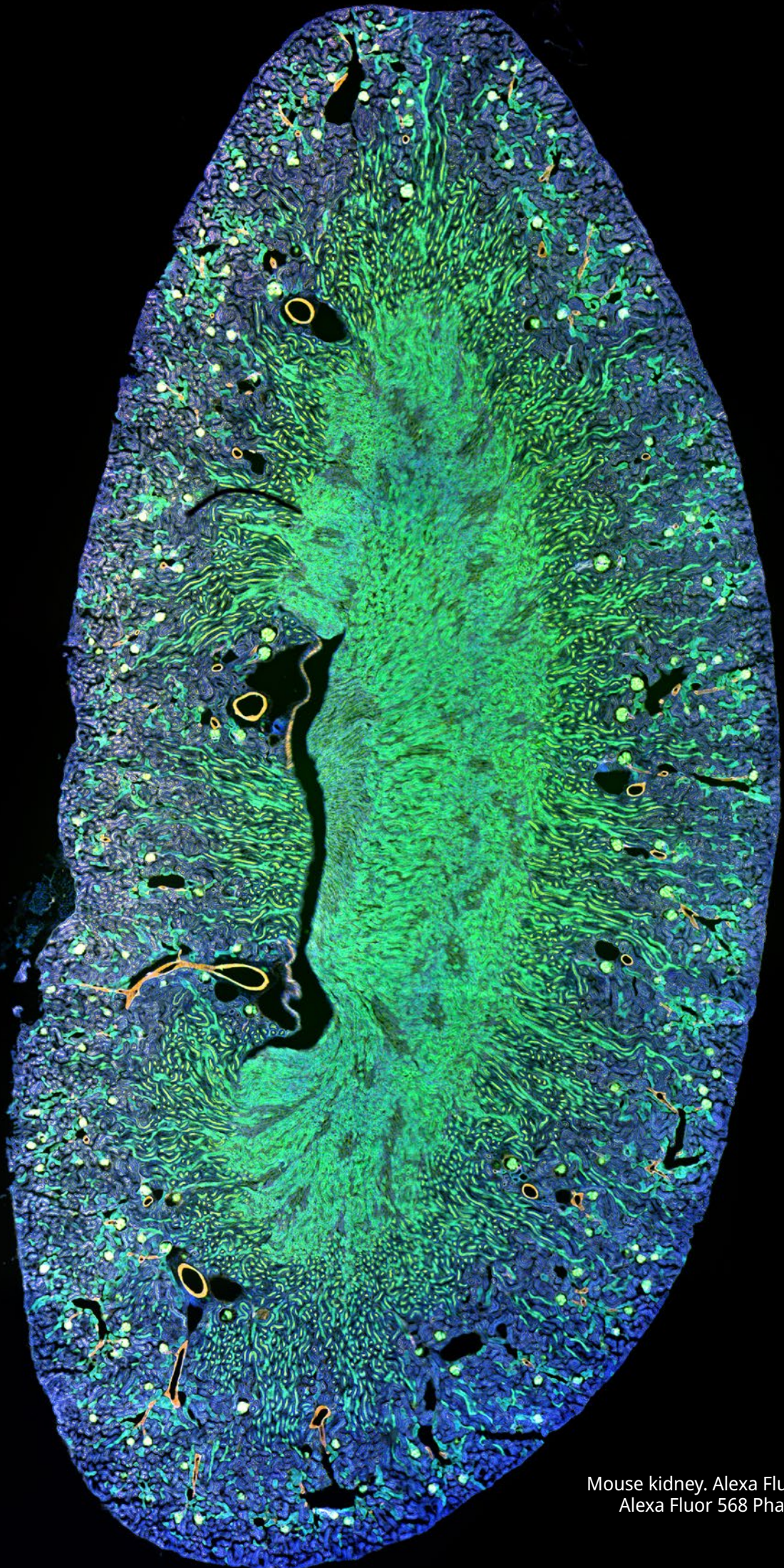

Mouse kidney. Alexa Fluor 488 WGA, Alexa Fluor 568 Phalloidin, DAPI.



See It in Action



## Gradient Contrast: See Your Sample in a New Light

Acquiring sharp images at the edges of a well in a multi-well plate can be challenging. The contrast is poor even when using oblique contrast, and DIC does not work well with plastic containers.

The APX100 microscope features our unique **gradient contrast method**. It works with all Olympus objectives and enables you to capture sharp images in a wider area and with higher contrast than the conventional method.

This unique contrasting method is less affected by the meniscus, container lids, and water droplets, and it can be used with both glass- and plastic-bottom dishes and multi-well plates. Gradient contrast also enables you to image through the plastic lids of Petri dishes and multi-well plates, reducing the risk of contamination when imaging your cells.

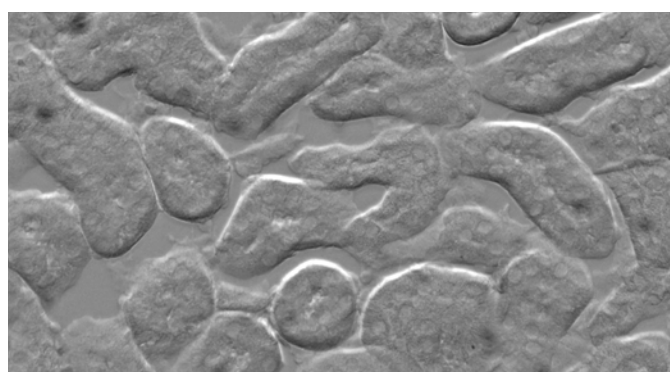

Captured with gradient contrast

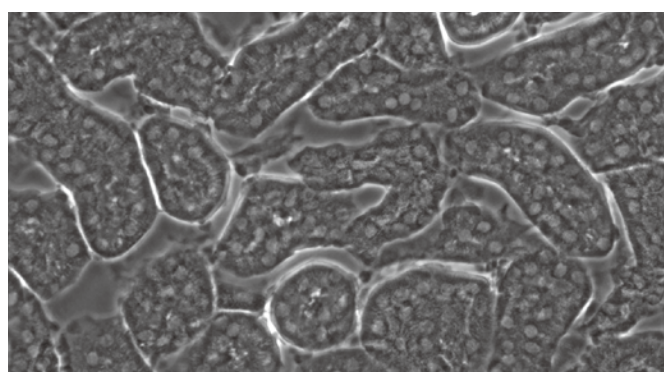

Captured with phase contrast

- Works with any Olympus objective
- Less affected by the meniscus, container lids, and water droplets
- Can be used with glass- and plastic-bottom dishes and multi-well plates
- Image through the plastic lids of Petri dishes and multi-well plates, reducing the risk of contamination

See It in Action



## Clearer Images with Motorized Spherical Aberration Correction

To get a clear image, it's important to account for the thickness of your cover glass and set your objective's correction collar. Typically, this requires you to manually and iteratively adjust the objective's collar to compensate. The APX100 system includes a motorized spherical aberration correction that is controlled by the software. You can choose preset conditions for glass or plastic containers or make custom adjustments to ensure image quality.

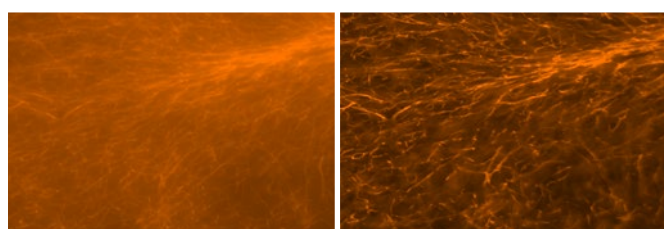

Rat brain slice, (left) Before spherical aberration correction, (right) Spherical aberration properly corrected



## Sample Images Captured with Gradient Contrast

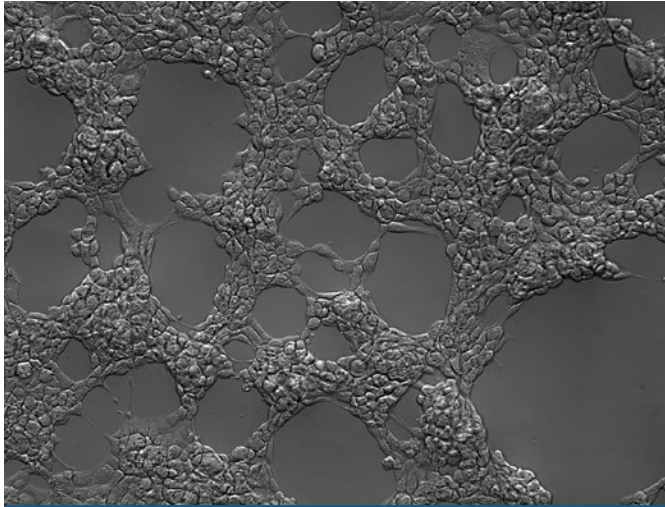

HEK-293 cells

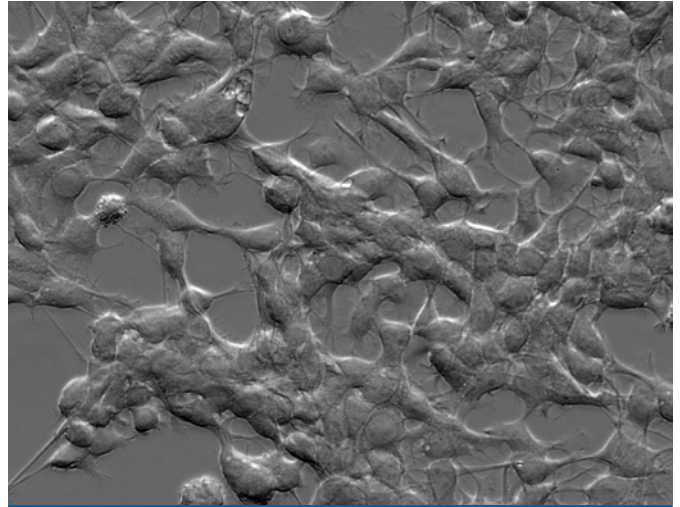

NG108 cells

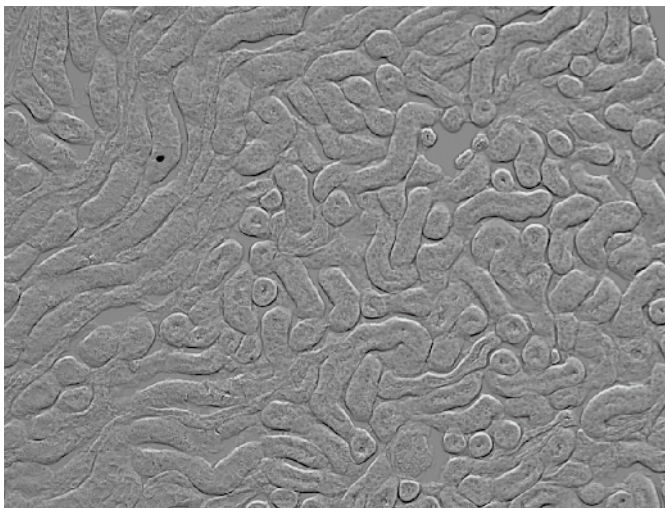

Mouse kidney

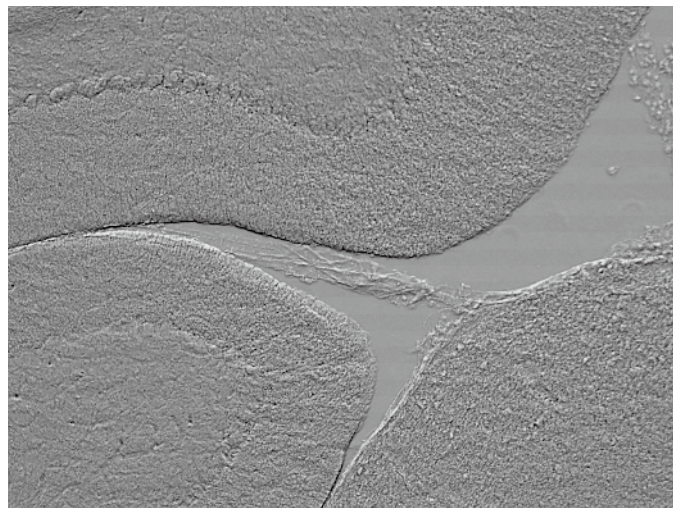

Rat brain

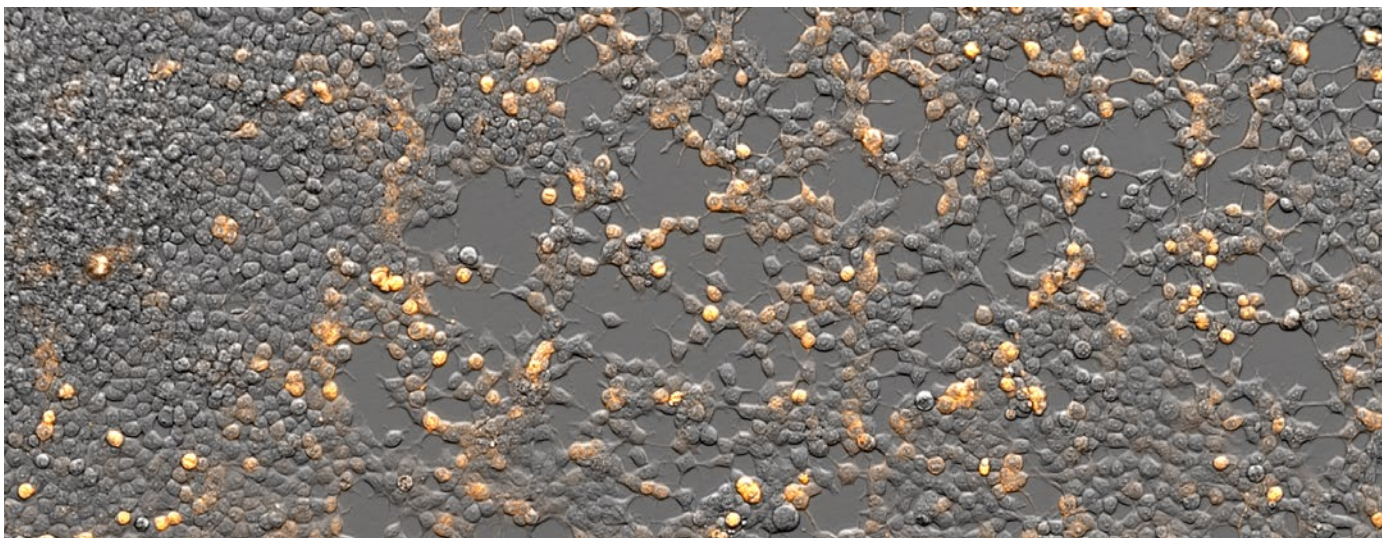

Expression of membrane-translocated mCherry in HEK293T cell\*

\*Image data courtesy of Rie Saba, Ph.D., Division of Developmental Biology and Anatomy, Department of Anatomy, Kyoto Prefectural University of Medicine.



## Tools for Clearer Images

### - Photobleaching Prevention Mode

Consistently bright incident light can cause photobleaching and phototoxicity that quickly degrades fluorescent samples. Using the system's photobleaching prevention mode, the fluorescence illumination source only emits excitation light for the time necessary to acquire the image. The static image is then displayed on the screen, providing you time to take measurements or evaluate captures while minimizing phototoxicity to delicate samples.



### - A Line 20X Objective for Plastic Containers



Our A Line 20X phase contrast objective (UCPLFLN20XPH) has a numerical aperture of 0.7, enabling bright, high-resolution imaging of cells in plastic dishes.



Phase contrast observation



Fluorescence observation



### - Automated Correction for Uneven Samples

Not all samples lay flat on dishes or slides. The system's built-in focus map allows you to set different focal planes for imaging while also correcting for sample tilt. This feature enables the system to display a sharp, stitched image with no focus shift, even for thick, uneven samples.

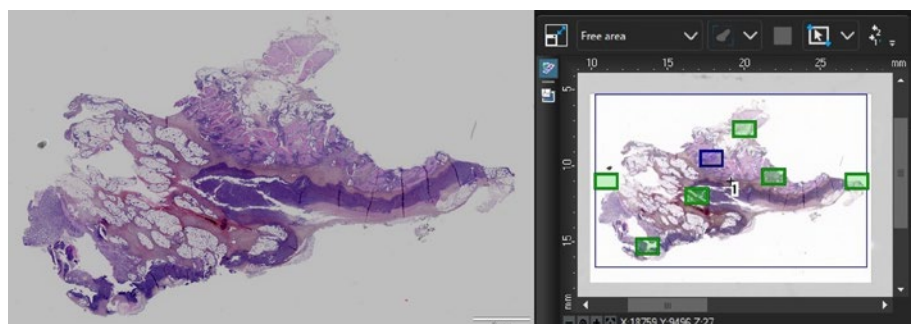



# Fast, Efficient Data Management

Managing experiment data is a common challenge when acquiring multiple types of images across experiments. The APX100 system includes features that enable fast, efficient data management that keeps your data organized and acquisition parameters saved for future reference.

## Images Are Organized and Easy to Find

The APX100 microscope has a dedicated system to organize and store your data. When you acquire an image, the software automatically creates folders for each sample and saves the data into the correct one. The consistent indexing keeps your data organized and easy to locate and keeps you from accidentally saving data in the wrong folder.

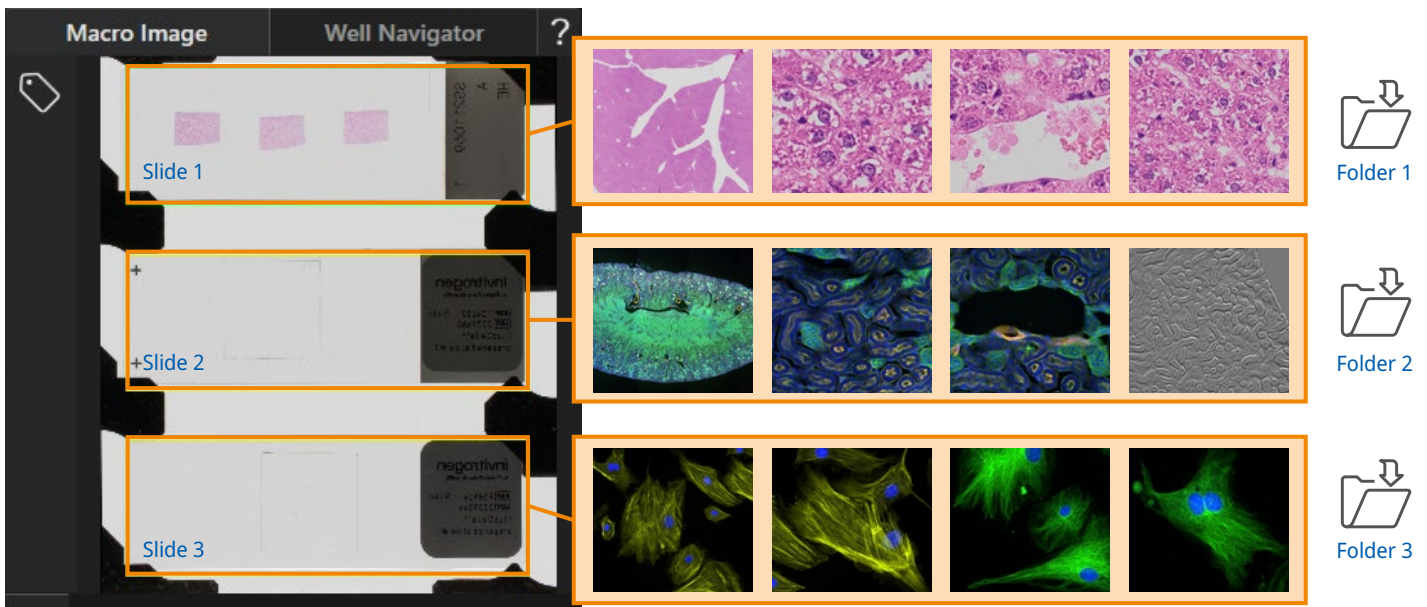

## Recall Image Acquisition Settings

Experimental conditions often need to be repeated to validate results or make comparisons between old and new sample data. The APX100 system helps ensure that all important acquisition settings are saved alongside image data so that it can be easily recalled for future experiments.

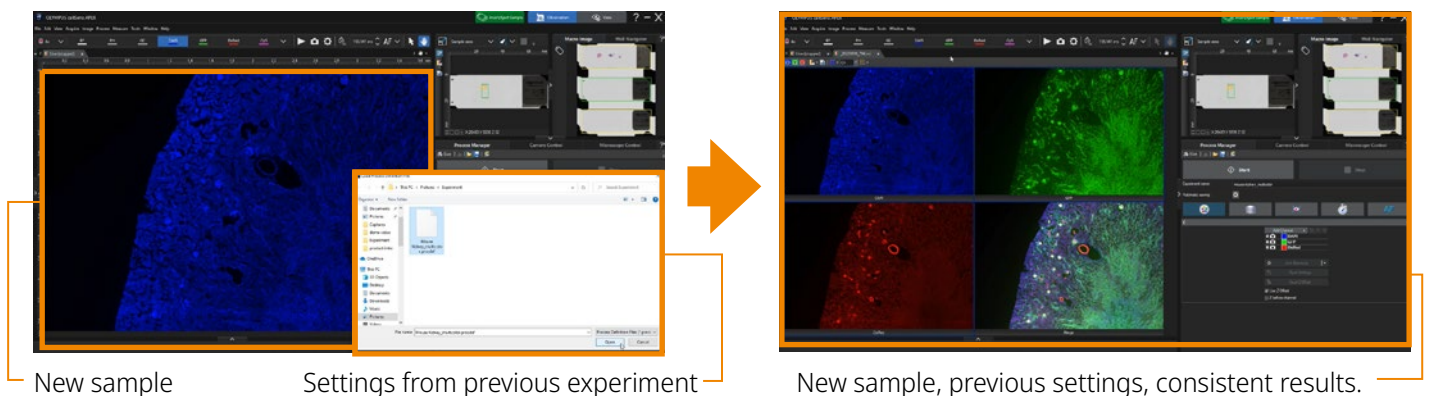

# Image Processing and Analysis

## TruSight Deconvolution

Fluorescence blur is a challenge when imaging thick specimens with widefield fluorescent microscopes. The APX100 features several tools for improving image quality, including online-deblur and TruSight deconvolution. The microscope's TruSight deconvolution algorithms improve image quality, enabling you to obtain a higher signal-to-noise ratio, enhance resolution, and see deeper in thick specimens. When used in combination with a silicone oil immersion objective—which enables high-resolution and deep observation of cells and tissues—it can be used to acquire detailed 3D images.

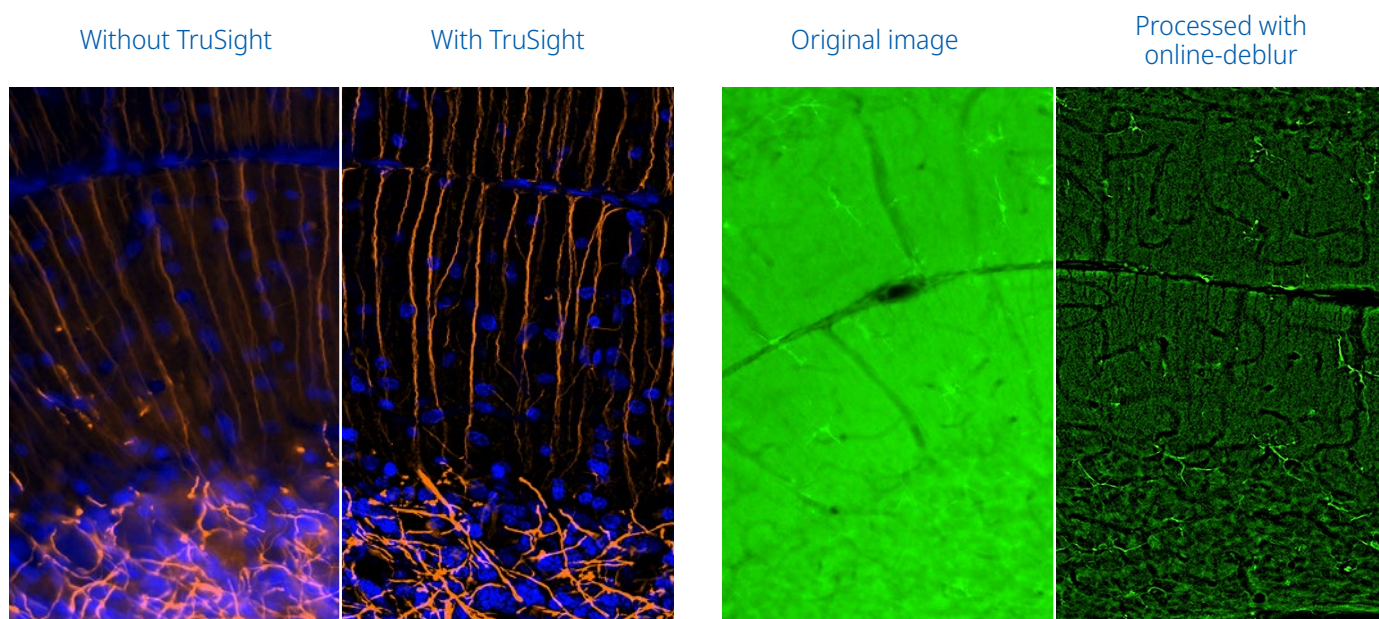

## cellSens Image Analysis

With an optional cellSens image analysis license, you can access various image processing techniques such as counting intracellular signals, analyzing the brightness of time-lapse data, and TruAI deep-learning technology. From predicting multiclass nuclei phenotypes for drug testing to rapid automated detection and segmentation of glomeruli, the TruAI deep-learning solution delivers efficient and reliable analysis results. The integration of cellSens software enables easy, on-the-spot processing for simple measurements and image export.

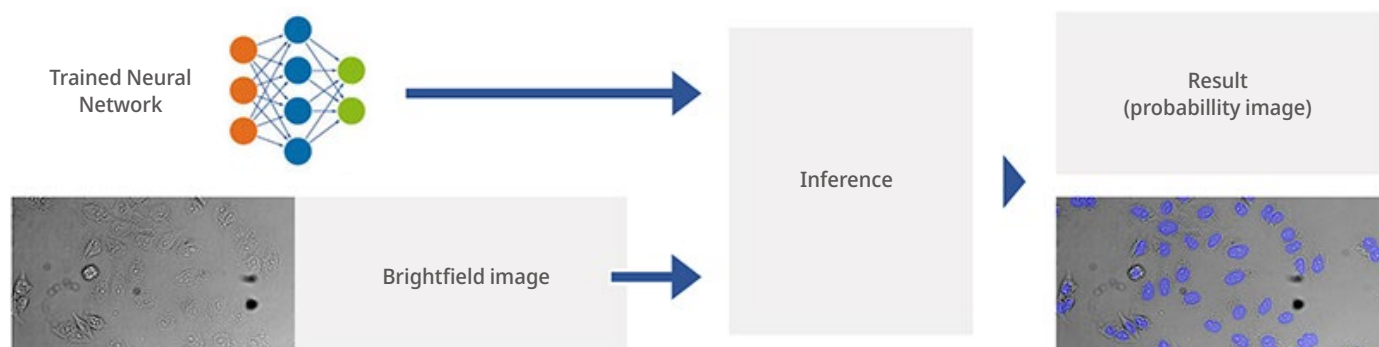



## Designed for Labs and Imaging Core Facilities

### No Darkroom Required

With a small footprint, built-in anti-vibration mechanism, and shielded optics, you can place the APX100 system almost anywhere. Install the unit directly on a lab table to image in parallel with other experiments, even in a brightly lit room.

### Easy to Learn, Easy to Teach

Teaching multiple imaging modalities to new researchers can be a time-consuming process, but the APX100 system's ease of use greatly simplifies and accelerates the training process. Researchers who are unfamiliar with microscopes can quickly learn to operate the system and capture publication-quality images, while microscopy experts will appreciate the system's automation and streamlined workflow.

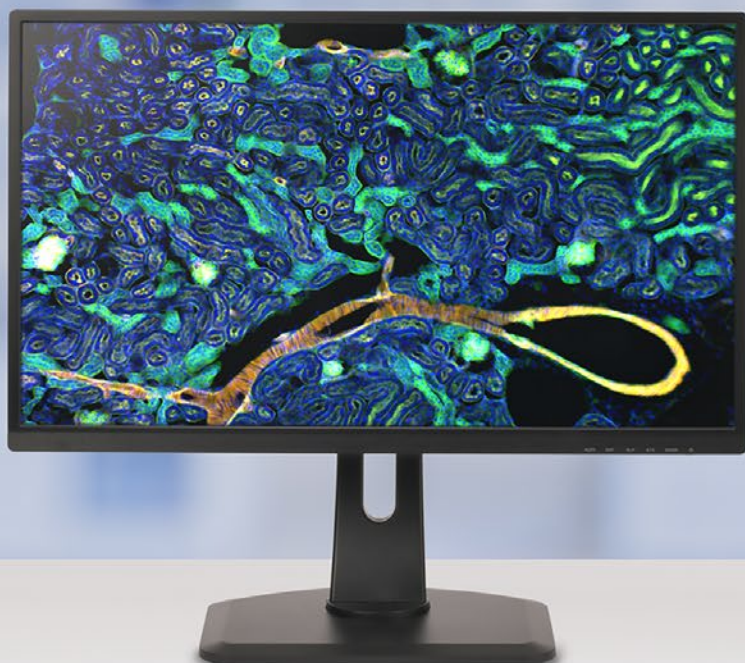

## Flexible for Many Applications

The APX100 microscope supports a wide range of research imaging applications for slides, dishes, and well plates. Use the included imaging methods such as multichannel, stitching, time-lapse, and Z-stack acquisition in any combination to fit your research protocol.

### Multichannel

- Observe samples with multiple stains and in combination with other imaging modes like phase contrast or gradient contrast.
- Capacity of up to eight mirror cubes to accommodate many experimental conditions.
- Capture images under optimal conditions quickly with automated exposure time and Z offset calibrations for each channel.
- Neatly displays merged images to ensure each acquisition matches your standards.

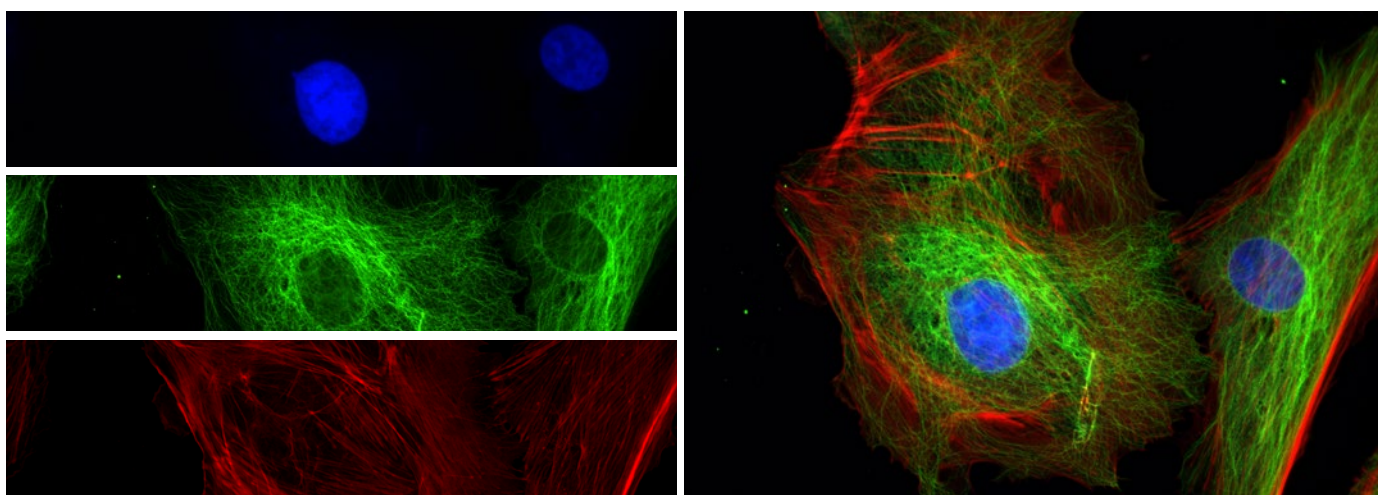

BPAE cells. Stain: Mouse Anti- $\alpha$ -tubulin, BODIPY FL Goat Anti-Mouse IgG, Texas Red-X Phalloidin, and DAPI.

### Stitching

- Capture entire tissue samples or assess the condition of cell culture flasks over wide areas rapidly at high resolution.
- High-accuracy stitching makes the joints between images nearly invisible in both brightfield and fluorescence acquisition modes.
- Even tilted or uneven samples can be cleanly stitched together.

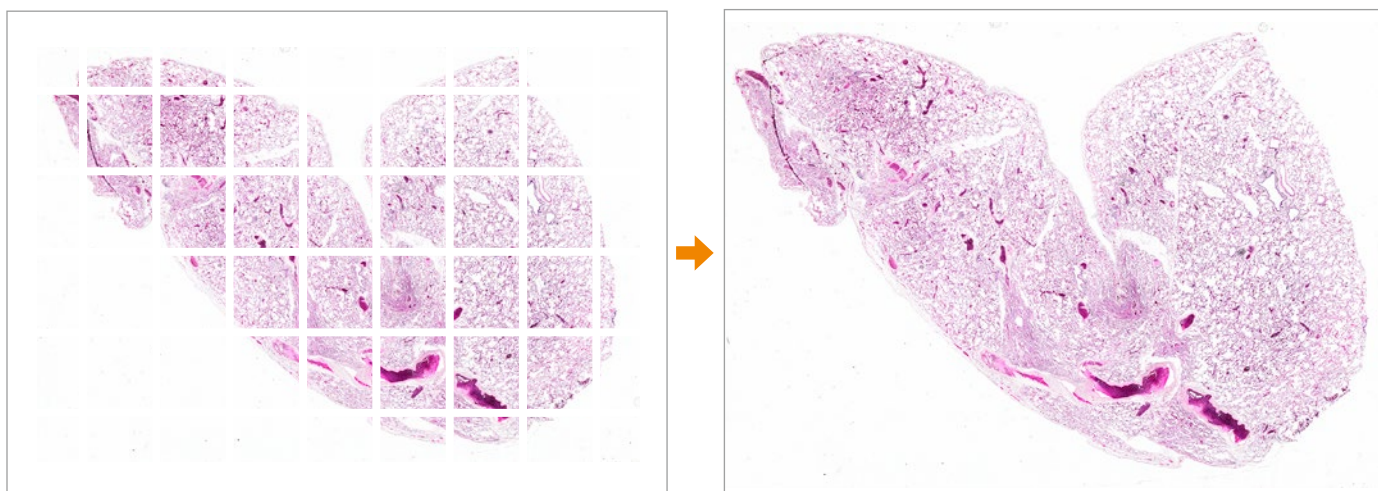

Mouse lung captured with UPLXAPO4X objective. Stain: HE.



## Z-Stack

- Acquire multiple images in the Z direction to accommodate thick samples.
- Create all-in-focus images with just a few clicks.
- Achieve sharp, blur-free images using TruSight™ deconvolution (see page 12 for more detail).

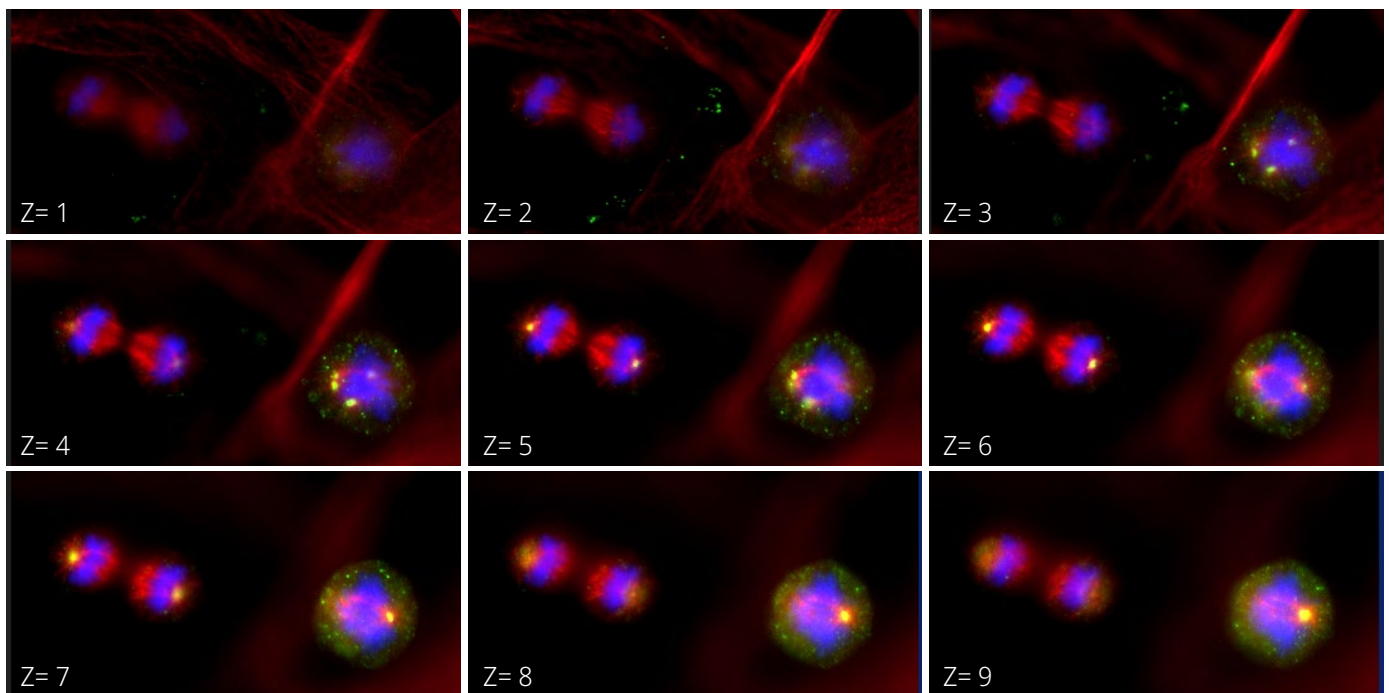
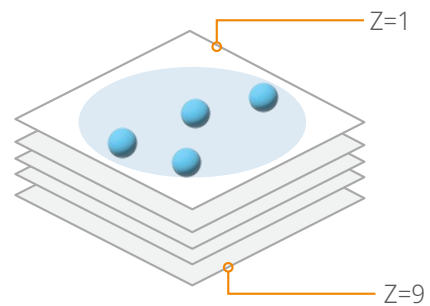

Subcellular localization of the centrosome protein kendrin/pericentrin. Stain: Pericentrin-green, alpha-tubulin-red, DNA-blue. Image data courtesy of Dr. Kazuhiko Matsuo, Anatomy and Developmental Biology, Kyoto Prefectural University of Medicine.

## Time Lapse

- Continuously record changes in a live cell or entire culture over time.
- A built-in vibration-isolation mechanism and optional incubator help ensure stable image acquisition.
- When combined with the optional drug administration unit, you can observe the response of cells immediately after drug administration in real time.

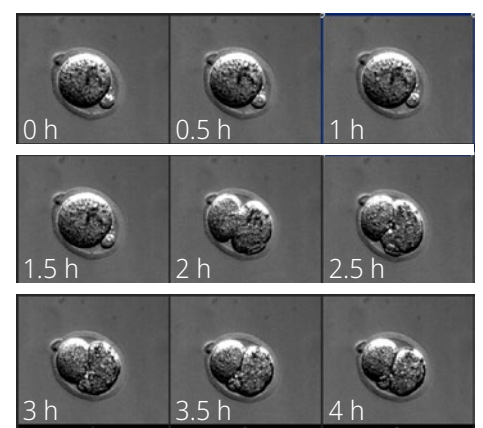

Time-lapse observation of a fertilized mouse egg every 30 minutes.

## Well Plate Navigation

- Simple and effective solution for experiments using well plates.
- Customize capture patterns using multiple observation points for each well.

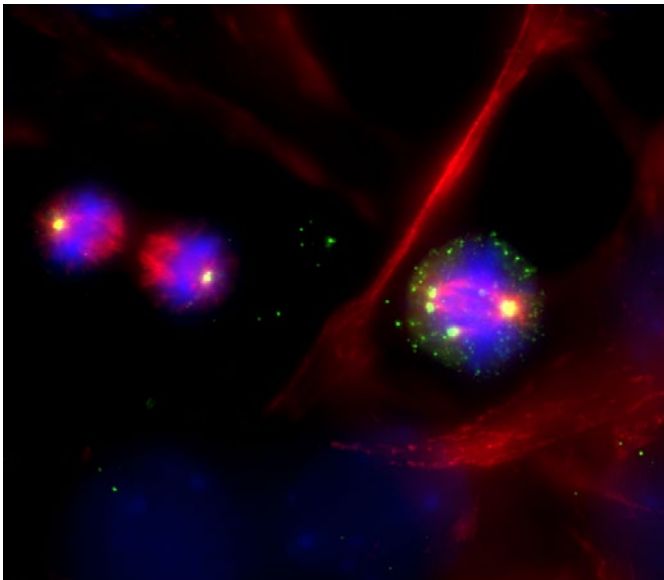

Subcellular localization of kendrin/pericentrin, centrosome protein \*

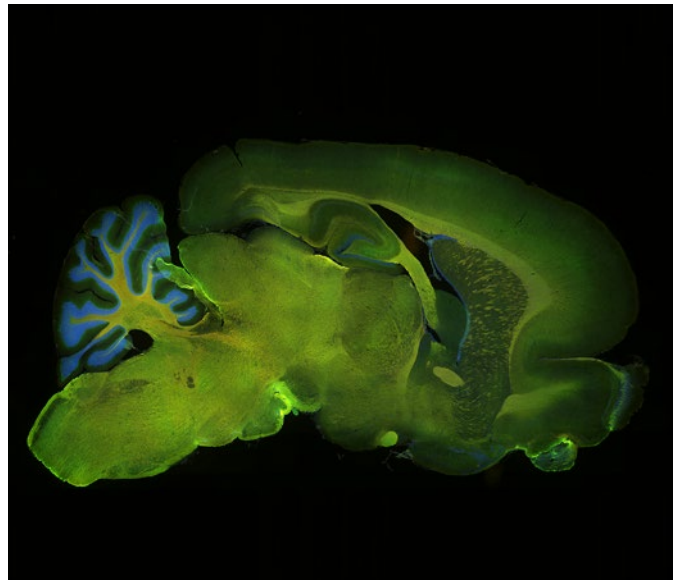

Transverse rat brain. Stain: Hoechst, RPCA-NF-L-ct, and MCA-7D5

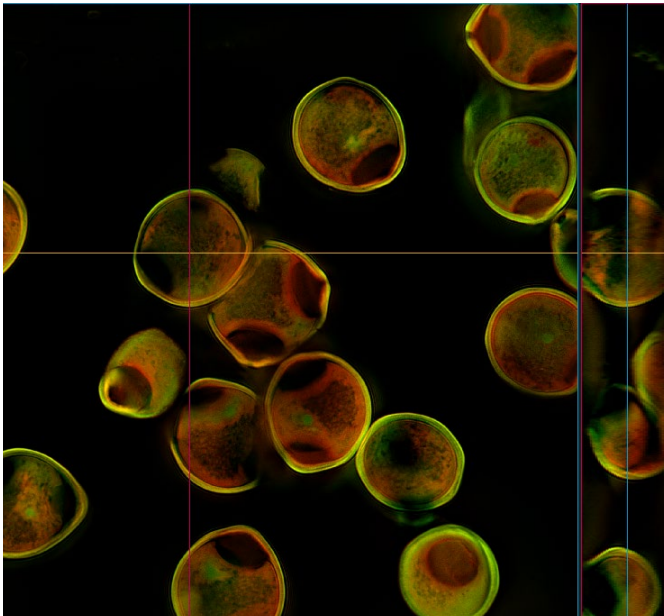

Hazel pollen

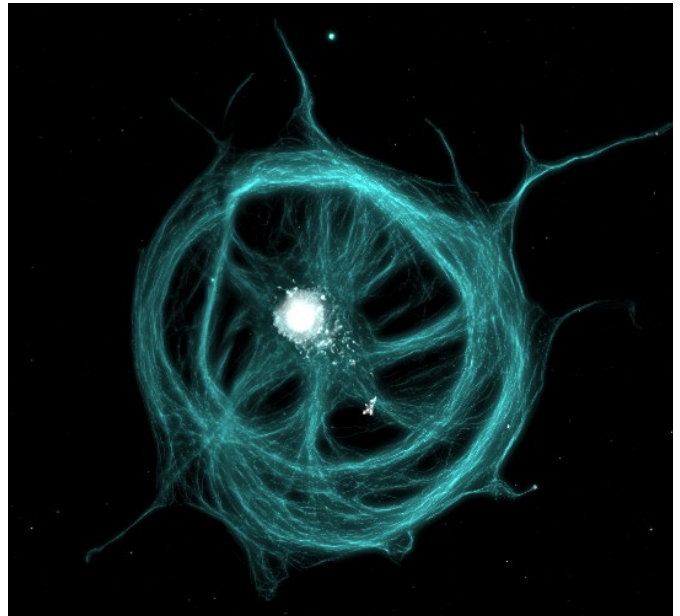

Tubulin and nucleus of BSC-1 cells

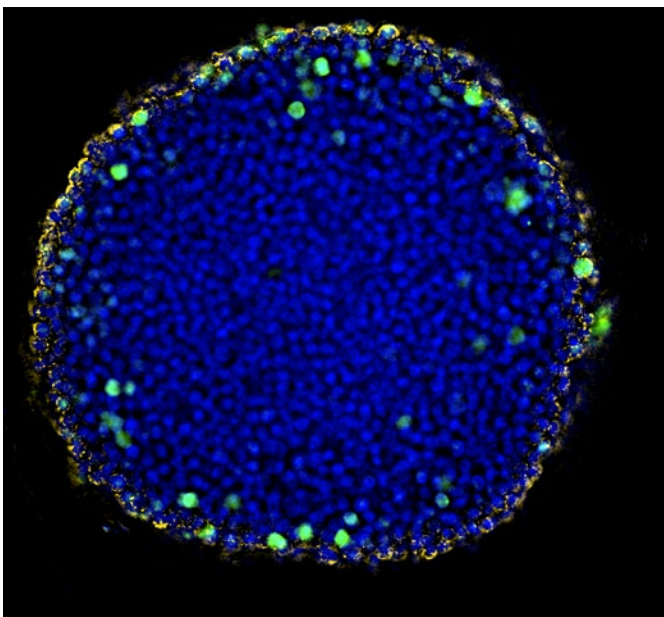

Cleared HeLa cell spheroid

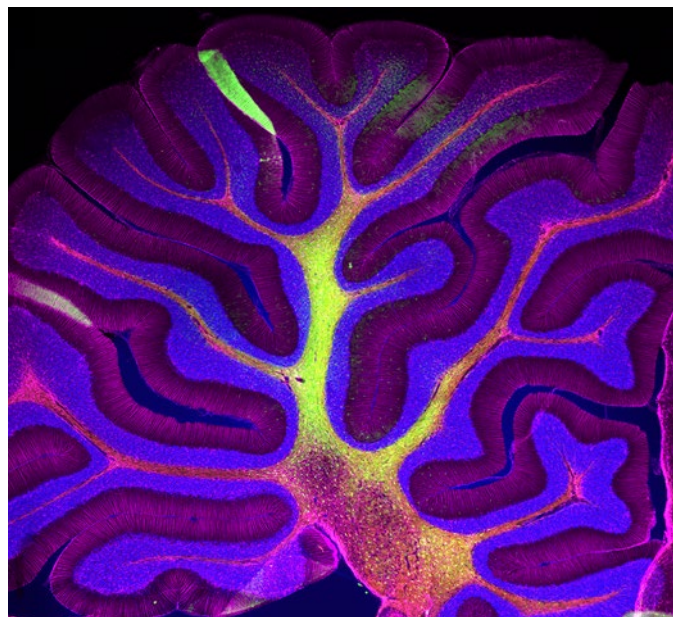

Rat brain

\*Image data courtesy of Dr. Kazuhiko Matsuo, Anatomy and Developmental Biology, Kyoto Prefectural University of Medicine.



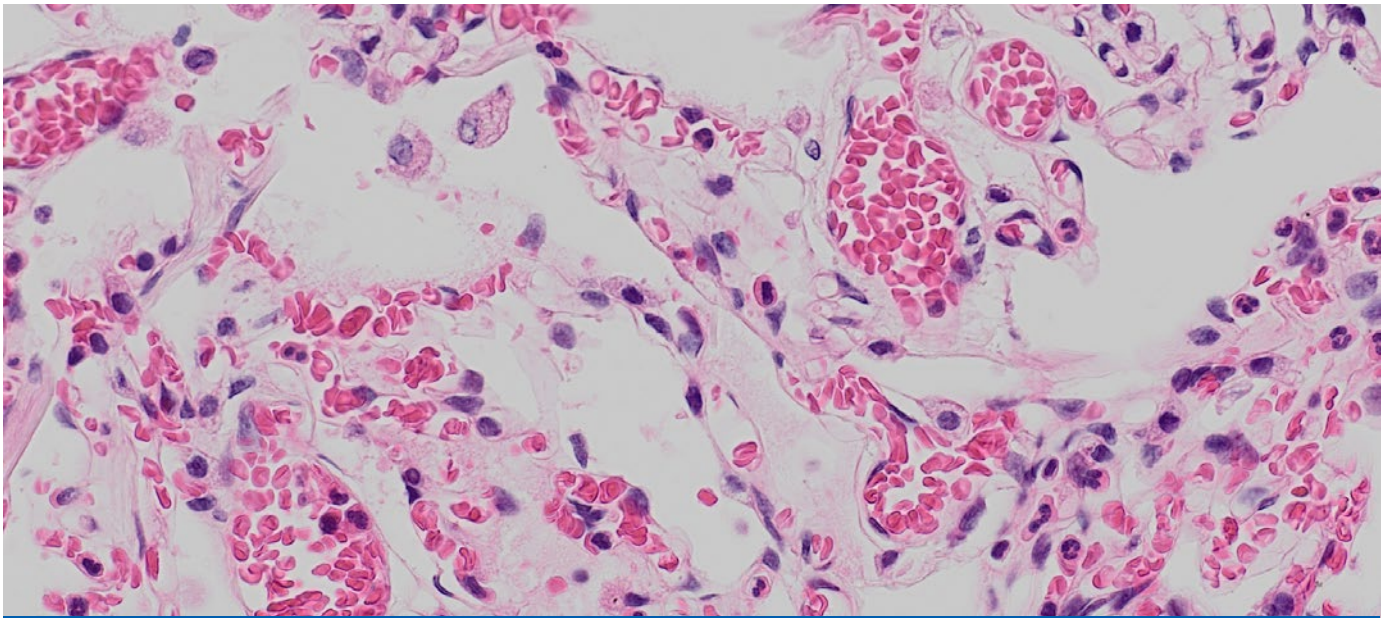

Lung

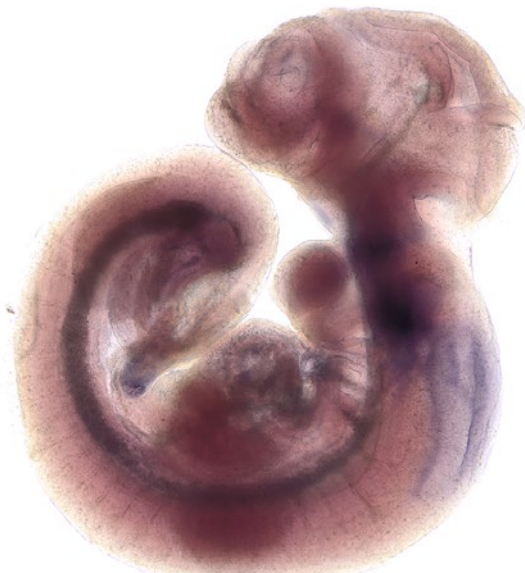

Cyp26a1 expression pattern in E9.5 mouse embryo by whole mount in situ hybridization\*

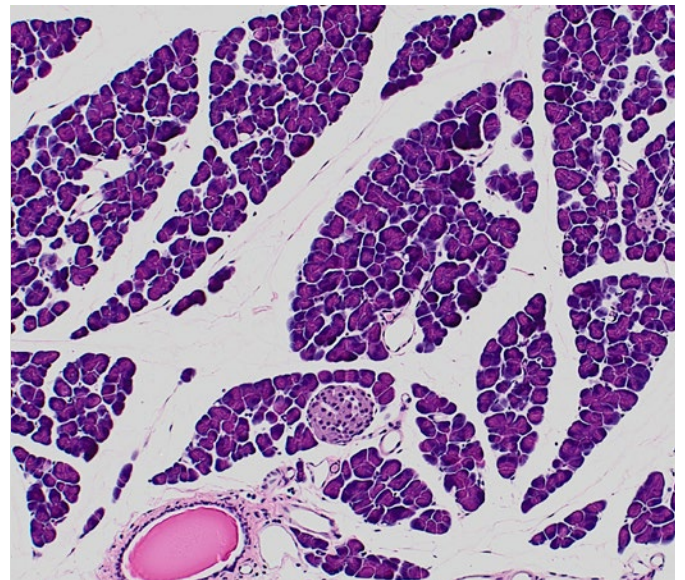

Pancreas

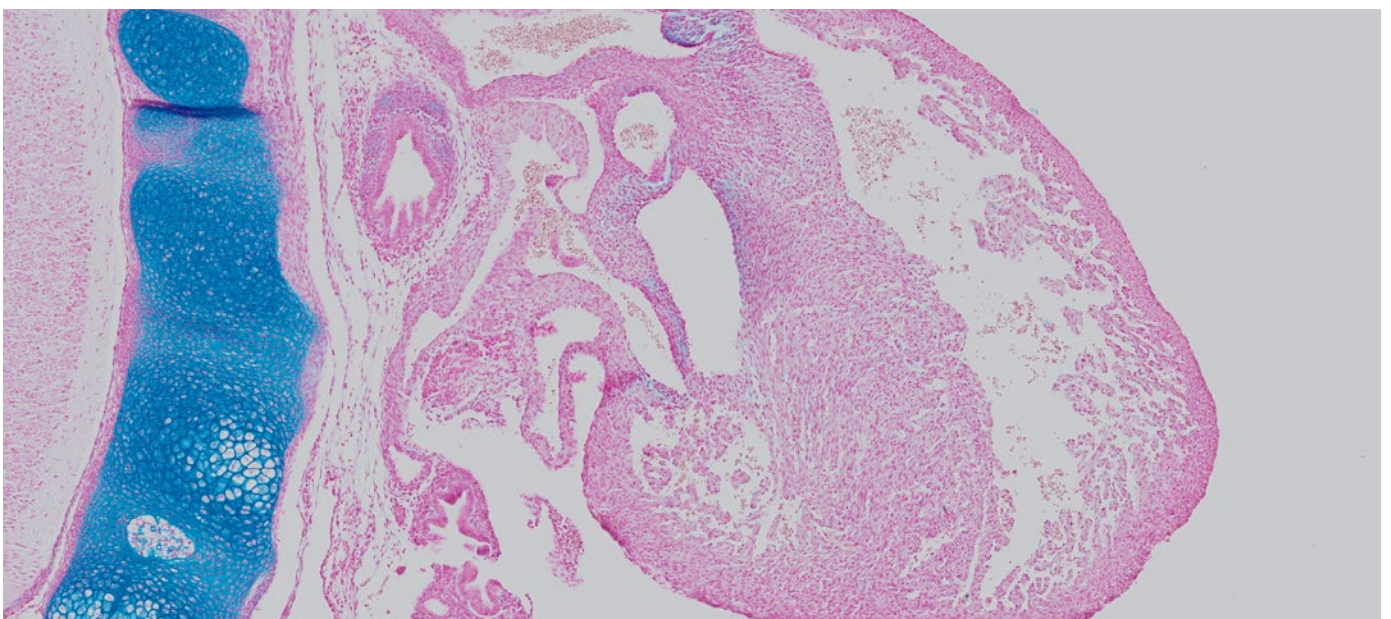

Alcian blue and nuclear fast red stained mouse embryo\*

\*Image data courtesy of <sup>1,2</sup>Naoki Takeshita, MD, <sup>1</sup>Kenta Yashiro Professor, MD, Ph.D., <sup>1</sup>Division of Developmental Biology and Anatomy, Department of Anatomy and <sup>2</sup>Department of Pediatrics, Graduate School of Medical Science, Kyoto Prefectural University of Medicine.

# Optional Units and Dimensions

Objectives					
UIS2 Objective		NA	W.D. (mm)	Cover glass thickness (mm)	Immersion medium
Universal Plan Extended Apochromat	UPLXAPO4X	0.16	13	-	
	UPLXAPO10X	0.40	3.1	0.17	
	UPLXAPO20X	0.80	0.6	0.17	
	UPLXAPO40X	0.95	0.18	0.11-0.23	
	UPLXAPO40XO	1.40	0.13	0.17	Oil
	UPLXAPO60XO	1.42	0.15	0.17	Oil
	UPLXAPO100XO	1.45	0.13	0.17	Oil
Universal Plan Extended Apochromat [Phase contrast]	UPLXAPO60XOPH	1.42	0.15	0.17	Oil
	UPLXAPO100XOPH	1.45	0.13	0.17	Oil
Universal Plan Super Apochromat [Silicone immersion]	UPLSAPO30XS	1.05	0.8	0.13-0.19	Silicone oil
	UPLSAPO40XS	1.25	0.3	0.13-0.19	Silicone oil
	UPLSAPO60XS2	1.30	0.3	0.15-0.19	Silicone oil
	UPLSAPO100XS	1.35	0.2	0.13-0.19	Silicone oil
Long Working Distance Universal Plan Semi-Apochromat	LUCPLFLN20XPH	0.45	6.6-7.8	0-2	
	LUCPLFLN40XPH	0.60	3.0-4.2	0-2	
	UCPLFLN20X	0.70	0.8-1.8	0-1.6	
	UCPLFLN20XPH	0.70	0.8-1.8	0-1.6	
Universal Plan Semi-Apochromat	UPLFLN4X	0.13	17	-	
	UPLFLN10X2	0.30	10	-	
	UPLFLN20X	0.50	2.1	0.17	
	UPLFLN40X	0.75	0.51	0.17	
	UPLFLN60X	0.90	0.2	0.11-0.23	
	UPLFLN100XO2	1.30	0.2	0.17	
Universal Plan Semi-Apochromat [Phase contrast]	UPLFLN4XPH	0.13	17	-	
	UPLFLN10X2PH	0.30	10	-	



Hamamatsu ORCA-Fusion\*



Photometrics Prime95B\*



Tokai Hit Incubator



Tokai Hit KSX-Type2



High Brightness Light Guide Light Source



Fluorescence LED Illuminator X-Cite XYLI5

\*High-sensitivity cameras are only available in the high-end camera unit (HCU) configuration.



## Mirror Units

Wavelength	Product name	Excitation	Emission	Dichroic mirror
Ultraviolet Excitations	U-FUW	340–390	420IF	410
	U-FUN	360–370	420IF	410
	U-FUNA	360–370	420–460	410
Blue Violet Excitations	U-FBWW	400–440	460IF	455
Blue Excitations	U-FBW	460–495	510IF	505
	U-FBWA	460–495	510–550	505
	U-FBN	470–495	510IF	505
	U-FBNA	470–495	510–550	505
Green Excitations	U-FGW	530–550	575IF	570
	U-FGWA	530–550	575–625	570
	U-FGNA	540–550	575–625	570
Yellow Excitations	U-FYW	540–585	600IF	595
Fluorescent Protein Variants	U-FCFP	425–445	460–510	455
	U-FGFP	460–480	495–540	490
	U-FYFP	490–500	515–560	515
	U-FRFP	535–555	570–625	565
	U-FMCHE	565–585	600–690	595
Free filter cube	U-FF	Free combination of filters and dichroic		

## APX100 Dimensions

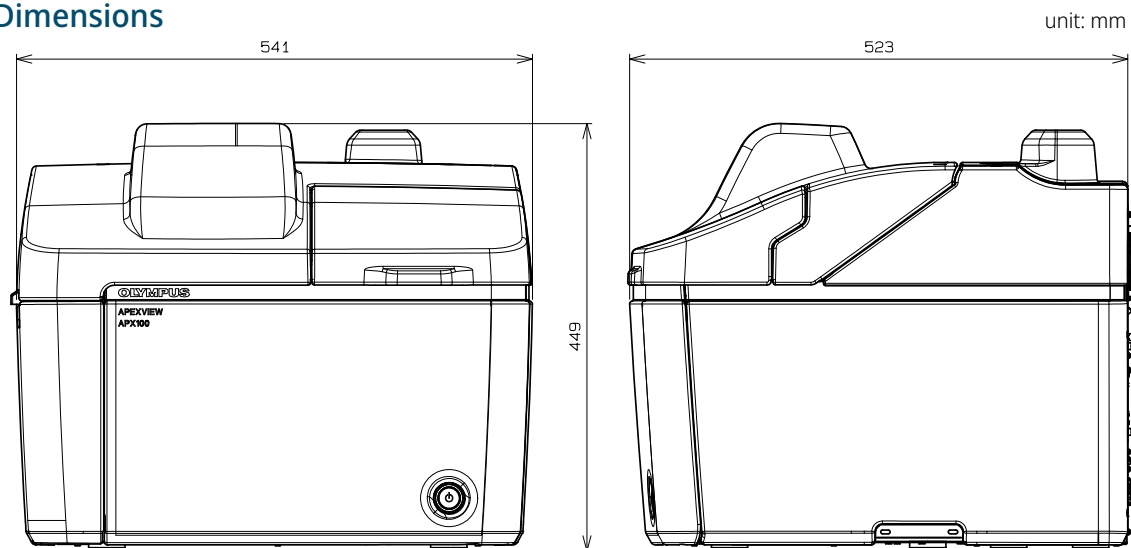

Dimensions do not include the high-sensitivity camera. The system size excluding the camera is common to both SU and HCU configurations.

# APX100 Specifications

		APX100-SU (standard unit)	APX100-HCU (high-end camera unit)	
Microscope	Observation method	Brightfield, fluorescence, phase contrast, gradient contrast		
	Sample holder	Glass slides (3 slides), 35 mm dish (3 dishes), microplate, general		
	Objectives	Choose from 25 available objectives (4X-100X)		
		Six-position motorized revolving nosepiece		
	Motorized aberration correction	One motorized position, five standard positions for objectives		
	Transmitted illuminator	Built-in Köhler illumination for transmitted light, high color rendering LED		
		Condenser: WD 45 mm, including PHL, PH1, PH2, and PH3		
	Stage	Motorized XY stage with automatic control		
	Focusing	Motorized focusing with automatic control		
	Magnification changer	Color/Monochrome 0.5x fixed	Color : 0.5x fixed Monochrome : 1x, 2x	
		Fluorescence	Fluorescence illuminator with fly-eye lens	
	Choose from 18 mirror cubes; eight-position motorized mirror turret			
	High brightness light guide light source (U-LGPS), Fluorescence LED illuminator (X-Cite XYLIS)			
Motorized ND filter changer (100%, 25%, and 6%)				
Macro optical system	Built-in, 0.07x macro optics			
Anti-vibration mechanism	Built-in			
Camera	Color camera	6.41 megapixels, 1/1.8 color CMOS		
	Monochrome camera	6.41 megapixels, 1/1.8 monochrome CMOS	High-sensitivity monochrome camera	
Software	Operation software	cellSens APEX, cellSens APEX Entry <sup>*1</sup>		
	Optional software	Time-Lapse CS-APS-TL-VF		
		Wellplate Navigator CS-S-WN-VF		
		Full Count and Measure CS-S-CM-VF		
	CI Deconvolution CS-S-DE-VF			
Optional units	Tokai Hit STX series (APX dedicated model)			
	Tokai Hit KSX-Type2			
Environment	Weight	34.6 kg (76.3 lb)	35.3 kg (77.8 lb)	
	Power consumption	70 W (APX100-SU/HCU only)		
	Power supply ratings	Input: AC 90-264 V, 50-60 Hz / Output: DC 24 V/5 A		

\*1 Optional software is not available for cellSens APEX Entry.

## System Requirements

OS	Microsoft Windows 10 Pro (64-bit), Microsoft Windows 11 Pro (64-bit)
CPU	Equivalent to Intel® Core™ processor (3.3GHz, 6 core, 18MB 3200MHz) or Intel® Core™ processor (2.7GHz, 14 core, 24MB 4800MHz)
RAM	16GB or more DDR4 SDRAM (ECC / Unbuffered / 16GB) or DDR5 SDRAM (4400MHz / ECC / Unbuffered / 16GB)
HDD	OS: 256 GB or more, Data: 2 TB or more
I/F	USB×4ports or more (or USB3.1 Gen1×2), RS-232C×1 port or more <sup>*2</sup>
Display	More than full HD 1920 × 1080 (fixed to full HD setting)

\*2 When using CPU; Intel® Core™ processor (2.7GHz, 14 core, 24MB 4800MHz), the RS232C serial card requires the following. FIFO buffer memory : 64 bytes or more.



**EVIDENT CORPORATION**  
Shinjuku Monolith, 2-3-1 Nishi-Shinjuku,  
Shinjuku-ku, Tokyo 163-0910, Japan

**EVIDENT Scientific, Inc.**  
48 Woerd Avenue  
Waltham, MA 02453, USA  
Tel.: (1) 781-419-3900

**EVIDENT Europe GmbH**  
Caffamacherreihe 8-10  
20355 Hamburg  
+49-402-3773-9112



EVIDENT CORPORATION is ISO 14001 certified. EVIDENT CORPORATION is ISO 9001 certified.  
All company and product names are registered trademarks and/or trademarks of their respective owners. Images on the PC monitors are simulated. Specifications and appearances are subject to change without any notice or obligation on the part of the manufacturer.  
Copyright © 2024 Evident Corporation

**EvidentScientific.com**  
N8602627-042024